



Technology for Vacuum Systems

CHEMISTRY PUMPING UNIT SERIES

PC 510 select
PC 511 select
PC 520 select
PC 610 select
PC 611 select
PC 620 select



Instructions for use

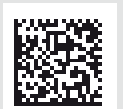

**Original instructions
Keep for further use!**

This manual is only to be used and distributed in its complete and original form. It is strictly the user's responsibility to carefully check the validity of this manual with respect to the product.

Manufacturer:
VACUUBRAND GMBH + CO KG
Alfred-Zippe-Str. 4
97877 Wertheim
GERMANY

Phone:

- Head office +49 9342 808-0
- Sales +49 9342 808-5550
- Service +49 9342 808-5660

Fax: +49 9342 808-5555
E-Mail: info@vacuubrand.com
Web: www.vacuubrand.com

*Thank you for purchasing this product from **VACUUBRAND GMBH + CO KG** .
You have chosen a modern and technically high quality product.*

TABLE OF CONTENT

1	Introduction	5
1.1	User information	5
1.2	About this document.	6
1.2.1	Manual structure	6
1.2.2	Display conventions	7
1.2.3	Symbols and icons	8
1.2.4	Handling instructions (action steps).	9
1.2.5	Abbreviations	9
1.2.6	Term definitions.	10
2	Safety information	12
2.1	Usage.	12
2.1.1	Intended use	12
2.1.2	Improper use.	13
2.1.3	Foreseeable misuse.	13
2.2	Obligations	14
2.2.1	Operator obligations	14
2.2.2	Personnel obligations	14
2.3	Target group description.	15
2.4	Safety precautions, general	16
2.4.1	Protective clothing.	16
2.4.2	Safety precautions	16
2.4.3	Laboratory and working materials.	17
2.4.4	Eliminate sources of danger	18
2.5	Motor protection	21
2.6	ATEX equipment category	22
2.7	Proper disposal	23
3	Product description	25
3.1	PC 511 VARIO select (schematic design)	25
3.2	Chemistry pumping unit series	27
3.3	Condensers and chillers.	29
3.3.1	Separator/condenser at the inlet.	29
3.3.2	Condenser at the outlet.	29
3.4	Examples of use	30
4	Installation and connection	32
4.1	Transport	32
4.2	Installation	33

4.3	Connection	35
4.3.1	Vacuum connection (IN)	35
4.3.2	Exhaust gas connection (EX)	37
4.3.3	Coolant connection at the condenser	38
4.3.4	Venting connection	39
4.3.5	Gas ballast (GB)	41
4.3.6	Electrical connection	42
5	Commissioning (operation)	44
5.1	Switch on	44
5.2	Operation	44
5.2.1	Control (→ see controller manual)	46
5.2.2	Operation with gas ballast	47
5.3	Decommissioning (switch off)	48
5.4	Storage	49
6	Troubleshooting	50
6.1	Technical support	50
6.2	Fault – Cause – Remedy	50
7	Cleaning and maintenance	54
7.1	Information about service jobs	55
7.2	Cleaning	57
7.2.1	Housing surface	57
7.2.2	Empty glass flask	57
7.2.3	Clean or replace molded PTFE-hose	58
7.3	Vacuum pump maintenance	59
7.3.1	Maintenance items	59
7.3.2	Change the diaphragms and valves	61
7.3.3	Change pressure relief valve at EK	71
7.3.4	Change device fuse	72
8	Appendix	73
8.1	Technical information	73
8.1.1	Technical data	73
8.1.2	Wetted materials	76
8.1.3	Rating plate	77
8.2	Ordering information	78
8.3	Service	81
8.4	Index	82
8.5	EC Declaration of Conformity	84

1 Introduction

This manual is part of your product. The manual applies to all variants of the pumping unit and is intended in particular for laboratory staff.

1.1 User information

Safety

Instructions for use
and safety

- Read this manual thoroughly and completely before using the product.
- Keep this manual in an easily accessible location.
- Correct use of the product is essential for safe operation. Comply with all safety information provided!
- In addition to this manual, adhere to the accident prevention regulations and industrial safety regulations applicable in the country of use.

General

General
information

- For easier readability, the general term *Pumping unit* is used as an equivalent to and instead of the product name *Chemistry pumping unit PC 5xx select* or *PC 6xx select*.
- If passing the product on to a third party, also give them this manual.
- The illustrations in this manual are only intended to facilitate comprehension.
- We reserve the right to make technical and design changes in the course of continuous product improvement.

Copyright

Copyright ©

The content of this manual is protected by copyright. Only copies for internal use are allowed, e. g., for professional training.

© **VACUUBRAND GMBH + CO KG**

Contact

Contact us

- If your manual is incomplete, you can request a replacement. Alternatively, you can use our download portal: www.vacuubrand.com
- You are welcome to contact us at any time in writing or by telephone if you would like more information, have questions about our products or wish to share feedback with us.
- When contacting our Service Department, please have the serial number and product type at hand see *Rating plate* on the product.

1.2 About this document

1.2.1 Manual structure

Modular instructions for use

The manuals have a modular structure with separate instruction modules for the controller, vacuum pumps, pumping units, and any accessories.

Instruction modules

Pumping unit series and instructions for use

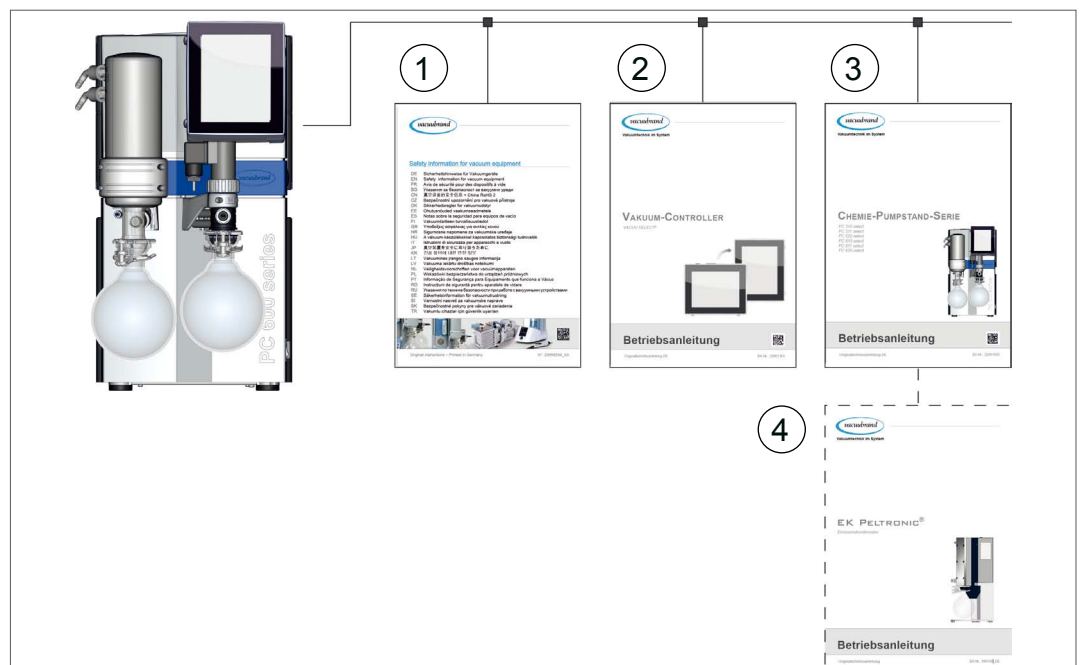

1 Safety information for vacuum equipment

2 Description: Vacuum controller – control and operation

3 Description: Pumping unit – connection, operation, maintenance, mechanics

4 Optional description: Accessories

1.2.2 Display conventions

Warning levels

Display conventions

	DANGER
	<p>Indicates an imminent hazardous situation. Disregarding the situation will result in serious and even fatal injury or death.</p> <p>⇒ Take appropriate action to avoid dangerous situation!</p>

	WARNING
	<p>Indicates a potentially hazardous situation. Disregarding the situation could result in serious, even fatal injury or massive damage to property.</p> <p>⇒ Take appropriate action to avoid dangerous situation!</p>

	CAUTION
	<p>Indicates a potentially hazardous situation. Disregarding the situation could result in slight or minor injury or damage to property.</p> <p>⇒ Take appropriate action to avoid dangerous situation!</p>

NOTICE	
<p>Notice for a potentially harmful situation. Disregarding the notice could lead to material damage.</p>	

Additional notes

IMPORTANT!

- ⇒ Information or specific use recommendation, which must be observed.
- ⇒ Important information for proper operation.

	<ul style="list-style-type: none"> ⇒ Helpful tips + tricks ⇒ Additional notes
---	---

1.2.3 Symbols and icons

This manual uses symbols and icons. Safety symbols indicate specific risks associated with handling the product. Symbols and icons are designed to help you identify risks more easily.









Safety symbols

Explanation of safety symbols

	Hazardous substance - hazards to human health.		General prohibition sign.
	General warning sign.		Warning Risk of explosion.
	danger: electricity		danger: hot surface
	General mandatory sign.		Disconnect mains plug.
	Wear chemical resistant protective gloves.		Wear protective goggles.
	Read instructions for repair.		

Additional icons

Additional symbols

	Positive example – Do this! Result – OK		Negative example – Don't do this!
	Refers to content in this manual.		Refers to content of other supplementary documents.
	Installation at temperatures < 40 °C (< 104 °F).		Ensure sufficient air circulation.
	Flow arrow Inlet – vacuum connection		Flow arrow Outlet – exhaust gas

1.2.4 Handling instructions (action steps)

Display of action steps

Instructions (single step)

⇒ Perform the step described.

- Result of action

Instructions (multiple steps)

1. First step

2. Next step

- Result of action

Perform the steps in the order described.

1.2.5 Abbreviations

Abbreviations

abs.	Absolute
AK	Separator flask
ATM	Atmospheric pressure (pressure graphic, program)
d_i (di)	Interior diameter
DN	Nominal diameter
ECTFE	Ethylene/Chlorotrifluoroethylene
EK	Vapor condenser
ETFE	Ethylene/Tetrafluoroethylene
EX*	Outlet (exhaust, exit), exhaust gas connection
	ATEX equipment labeling
FFKM	Perfluoroelastomer
FPM	Fluoroelastomer
GB	Gas ballast
Size	Size
IN*	Inlet, vacuum connection
KF	Small flange
max.	Maximum value
min.	Minimum value
PA	Polyamide
PBT	Polybutylene terephthalate
PC	Chemistry pumping unit with type identification number
PE	Polyethylene
PET	Polybutylene terephthalate
PP	Polypropylene
PPS	Polyphenylene sulphide

Abbreviations	PTFE	Polytetrafluorethylene
	PVDF	Polyvinylidene fluoride
	RMA-N°	Return Merchandise Authorization number
	SW	Wrench size (tool)
	resp.	responsible (supervising)
	e. g.,	for example

* Labeling on vacuum pump or component

→ see also *Product-specific abbreviations on page 29*

1.2.6 Term definitions

Product-specific terms	Separator flask	Glass flask / separator mounted at the inlet or outlet.
	Vapor condenser*	Cooling condenser with receiving flask mounted at the outlet (pressure side).
	Flow control valve	Valve at the inlet of PC 511/611 select for manual vacuum control
	PC 5xx select PC 6xx select	Vacuum pumping unit with valves for manual and/or electronic vacuum control including VACUU-SELECT® controller and VACUU-SELECT® Sensor .
	VACUU-BUS®	Bus system from VACUUBRAND for communication between peripheral devices with VACUU-BUS® enabled gauges and controllers. The maximum admissible cable length is 30 m.
	VACUU-BUS® address	Address which enables the VACUU-BUS® client to be unambiguously assigned within the bus system, e.g., for connecting multiple sensors with the same measurement range.
	VACUU-BUS® client	Peripheral device or component with VACUU-BUS® port which is integrated in the bus system, e. g., sensors, valves, level indicators, etc.
	VACUU-BUS® connector	4-pin round connector for the bus system from VACUUBRAND .
	VACUU-BUS® configuration	Using a measuring device or controller, e. g, VACUU-SELECT® , assign another VACUU-BUS® address to a VACUU-BUS® component.
	VACUU-SELECT®	Vacuum controller, controller with touchscreen; consisting of operating panel and vacuum sensor.

Product-specific
terms

VACUU-SELECT[®] Vacuum sensor with integrated venting valve.
Sensor

** only suitable for condensation of vapors*

2 Safety information

The complete information of this chapter must be observed by all persons working with the described product herein.

The safety instructions are valid for the complete life cycle of the product.

2.1 Usage

Only use the product if it is in perfect working condition.

2.1.1 Intended use

Intended use A chemistry pumping unit of the *PC 500/600 select* product series is a vacuum system consisting of a vacuum pump, controller, sensor and separator, for the creation and control of rough vacuum in designated systems, e. g., evacuating distillation instruments, as a vacuum dryer or systems with VACUU·LAN local area vacuum network, etc.

Attached chillers (vapor condenser), including separators and flasks, are exclusively intended for vapor condensation.

The vacuum system may only be used indoors in a non-explosive atmosphere.

Intended use also includes:



- observing the information in the document **Safety information for vacuum equipment**,
- observing the manual,
- observing the manual of connected components,
- observing the inspection and maintenance intervals and having it performed by appropriately qualified personnel.
- using only approved accessories or spare parts.

Any other use is considered improper use.

2.1.2 Improper use

Improper use Incorrect use or any application which does not correspond to the technical data may result in injury or damage to property.

Improper use includes:

- using the product contrary to its intended use,
- operation at improper environmental and operating conditions,
- operation despite obvious malfunctions or defective safety devices,
- unauthorized modifications or conversions, in particular when these impair safety,
- usage despite incomplete assembly,
- operation with sharp-edged objects,
- pulling plug-in connections on the cable out of the socket,
- to pump, to convey and to compress solids or fluids.

2.1.3 Foreseeable misuse

Foreseeable misuse In addition to improper use, there are types of use which are prohibited when handling the device:

Prohibited types of use are, in particular:



- use on humans or animals,
- installation and operation in potentially explosive atmospheres,
- use in mines or underground,
- using the device to generate pressure,
- fully exposing vacuum devices to the vacuum,
- immersing it in liquids, exposing it to water spray or steam jets,
- pumping oxidizing and pyrophoric substances, liquids or solids,

- Foreseeable misuse
- pumping of hot, unstable, or explosive media,
 - pumping substances which may react explosively under impact and/or elevated temperature without an air supply.

IMPORTANT!

The penetration of foreign objects, hot gases and flames from the application, must be excluded.

2.2 Obligations

2.2.1 Operator obligations

Operator obligations

The owner defines the responsibilities and ensures that only trained personnel or specialists work at the vacuum system. This applies in particular to connection, assembly and maintenance work and troubleshooting.

Users in the areas of competence in the *Zuständigkeitsmatrix* must possess the relevant qualifications for the activities listed. In particular work on electrical equipment must be performed only by qualified electricians.

2.2.2 Personnel obligations

Personnel obligations

In the case of activities which require protective clothing, personal protective equipment as specified by the operator is to be worn.

If the vacuum system is not in proper order, it must be secured against being accidentally switched back on.

⇒ Always be conscious of safety and work in a safe manner.

⇒ Observe instructions issued by the operator, and national regulations on accident prevention and industrial safety.



Personal behaviour may help to avoid work accidents.

2.3 Target group description

Target groups The manual must be read and observed by every person who is tasked with the activities described below.

Personnel qualification

Qualification description	Operator	Laboratory staff, such as chemists, laboratory technicians
	Specialist	Person with professional qualification in mechanics, electrical equipment or laboratory devices
	Responsible specialist	Similar to a specialist, with additional specialist responsibility, or responsibility for a department or division

Responsibility matrix

Responsibility Assignment Matrix

Activity	Operator	Specialist	Responsible specialist
Installation	x	x	x
Commissioning	x	x	x
Network integration			x
Operation	x	x	x
Error report	x	x	x
Remedy	(x)	x	x
Maintenance		x	x
Repair ¹		x	x
Repair order			x
Cleaning, simple	x	x	x
Empty separator flask	x	x	x
Shutdown	x	x	x
Decontamination ²		x	x

1 see also website: VACUUBRAND > Support > [Instructions for repair](#)

2 Alternatively, arrange for decontamination by a qualified service provider

2.4 General safety instructions

Quality standards
and safety

Products from **VACUUBRAND GMBH + CO KG** are subject to stringent quality testing with regard to safety and operation. Prior to delivery each product has been tested thoroughly.

2.4.1 Protective clothing

Protective clothing

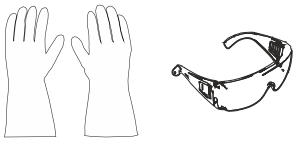

For operation no special protective clothing is required. Observe the owners' directives at work for your workplace.

During cleaning, maintenance and repair work, we recommend wearing full protective gloves, protective clothing and protective goggles.

IMPORTANT!

⇒ When handling chemicals, wear your personal protective equipment.

2.4.2 Safety precautions

Safety precautions

- ⇒ Use the vacuum device only if you have understood its function and this manual.
- ⇒ Replace defective parts immediately, e. g., a broken cable, faulty flask or faulty hose.
- ⇒ Use only original accessories and components which are designed for the vacuum technology, such as a vacuum hose, separator, vacuum valve, etc.
- ⇒ When handling contaminated parts, follow the relevant regulations and safety precautions, this also applies to equipment sent in for repair.

IMPORTANT!

Prior to any service, contamination from hazardous substances needs to be excluded.

⇒ Fill out the [Health and Safety Clearance form](#) in full and confirm with your signature.

2.4.3 Laboratory and working materials

	DANGER
	<p>Hazardous substances could emit at the outlet. During aspiration, hazardous, toxic substances at the outlet can get into ambient air.</p> <ul style="list-style-type: none"> ⇒ Observe the national regulations for safe handling of hazardous substances. ⇒ Please note that residual process media may pose a danger to people and the environment. ⇒ Mount and use suitable separators, filters or fume hood devices.

Risks due to various substances

Pumping different substances

Pumping different substances or media can cause the substances to react with one another.

Working substances which get into the vacuum pump with the gas flow can damage the vacuum pump. Hazardous substances can deposit in the vacuum pump.

Possible safety precautions, depending on the application:

- ⇒ Flush the vacuum pump with inert gas or air before changing the medium to be pumped.
- ⇒ Use inert gas to dilute critical mixtures.
- ⇒ Prevent the release of hazardous, toxic, explosive, corrosive fluids, gases or vapors or those that are harmful to health or the environment, for example, through suitable laboratory facilities with a fume hood and ventilation control.
- ⇒ Protect the inside of the vacuum pump from deposits or moisture, e. g, through the provision of a gas ballast.
- ⇒ Be aware of interactions and possible chemical reactions of the pumped media.
- ⇒ Check the compatibility of the pumped substances with the wetted materials of the pumping unit.
- ⇒ Contact us if you have concerns about using your vacuum pump with certain working materials or media.

2.4.4 Eliminate sources of danger

Take mechanical stability into account

Note
mechanical load
capacity

Due to the high compression ratio of the pump, pressure can develop at the outlet which exceeds that which the mechanical stability of the system allows.

- ⇒ Always ensure that the exhaust gas line is clear and non-pressurized. To ensure unhindered emission of gases, the outlet should not be blocked.
- ⇒ Prevent uncontrolled overpressure, e. g, due to a locked or blocked piping system, condensate or clogged exhaust gas line.
- ⇒ At the gas connections, the connections for the inlet *IN* and outlet *EX* should not be mixed up.
- ⇒ Be aware of the max. pressures at the inlet and outlet of the pump as well as the max. admissible differential pressure between the inlet and outlet, according to **8.1.1 Technical data on page 74**
- ⇒ The system to be evacuated as well as all hose connections must be mechanically stable.
- ⇒ Fix coolant hoses to the hose nozzles such that they cannot inadvertently become loose.

Prevent condensate reflow

Prevent backup in
the exhaust gas line

Condensate can damage the pump head. No condensate should flow back into the outlet *EX* and pump head due to the hose line. No liquid should accumulate inside the exhaust hose.

- ⇒ Avoid condensate return by using a separator. No condensate must enter the housing interior via the vacuum hoses.
- ⇒ Preferably lay the exhaust gas hose such that it descends from the outlet; that is, position it running downward so that no backup forms.

Avoid incorrect measurements

Incorrect measurement due to an obstructed vacuum line, e. g., condensate in the vacuum line can distort the measurements of the vacuum sensor.

⇒ Prevent overpressure > 1060 mbar (795 Torr) inside the suction line.

Avoid foreign bodies inside the pump

Observe vacuum pump dimensioning

Particles, liquids and dusts should not get inside the vacuum pump.

⇒ Do not pump any substances which could form deposits inside the vacuum pump.

⇒ Install suitable separators and/or filters upstream of the inlet. Suitable filters are chemically resistant, clog-proof and have a reliable flow rate, for example.

Risks during venting

Be aware of risks during venting

Depending on the application, venting can cause explosive mixtures to form or other hazardous situations to arise.

Risks due to residual energy

Possible residual energies

After the vacuum pump has been switched off and disconnected from the power supply, there may still be dangers at the plug-in power supply due to residual energy:

■ Thermal energy: Motor waste heat, hot surface, compression heat.

⇒ Allow the vacuum pump to cool off.

■ Electrical energy: In capacitors on the electronics, they have a discharge time of up to 5 seconds.

⇒ Wait until the capacitors have discharged.

Risk of burns due to hot surfaces or overheating

- Surface temperatures The surface of the vacuum pump can reach operating temperatures > **70 °C**, in particular when pumping heated media.
- ⇒ Avoid direct contact with the surface.
 - ⇒ Use protection against accidental contact if the surface temperature is regularly elevated.
 - ⇒ Allow the vacuum pump to cool off before performing maintenance work.
- Overheating The vacuum pump can be damaged due to overheating. Possible causes include insufficient air supply to the fan and failure to maintain minimum distances.
- ⇒ When installing the device, ensure that there is a minimum distance of 5 cm between the cooling fan and adjacent parts (such as the housing, walls, etc.).
 - ⇒ Always ensure a sufficient air supply; if applicable, provide external forced ventilation.
 - ⇒ Place the device on a stable surface; a soft surface such as foam rubber as a sound absorber can impair and block the air supply.
 - ⇒ Clean polluted ventilation slots.
 - ⇒ Remove covers from the device before operating it.
 - ⇒ Avoid excessive heat input due to hot process gases.
 - ⇒ Observe the maximum admissible media temperature
→ see *chapter: 8.1.1 Technical data on page 74*.

Keep signs legible

Warning signs and labels

Keep labels and information symbols and warning labels always in a well readable condition:

- ⇒ Connection labeling
- ⇒ Warning signs and notice labels
- ⇒ Motor data and rating plates

2.5 Motor protection

Overheating protection, deadlock protection

The pump motor has a locked thermal winding protection as overload protection. In the event of excessive temperature or if the motor is blocked, the vacuum pump switches off.

Procedure for switching vacuum pump back on

If the vacuum pump is switched off due to these safety precautions, the error must be cleared manually: Unplug pumping unit from power supply -> eliminate cause of error -> after a waiting time of ca. 5 minutes switch pumping unit back on.

	CAUTION
	<p>Limited winding protection in the case of supply voltages less than 100 V.</p> <p>In the case of supply voltages less than 100 V, the self-retention of the winding protection may be limited such that the pump may automatically start up after cooling.</p> <p>⇒ Take appropriate safety precautions.</p>

2.6 ATEX equipment category

Installation and potentially explosive atmospheres



The installation and operation in areas where potentially explosive atmospheres can develop to a hazardous degree is not permitted.

ATEX approval only applies to the internal, wetted parts of the of the product, not to its surroundings.

ATEX equipment labeling

ATEX
equipment category



Vacuum equipment labeled with ϵx has ATEX approval in line with the ATEX marking on the rating plate.

- ⇒ Only use the product if it is in perfect working condition.
- ⇒ The devices are designed for a low level of mechanical stress and must be installed in such a way that they cannot sustain mechanical damage from the outside.

ATEX
equipment category
and
peripherals

The ATEX category of the product is dependent on the connected peripheral devices. Components and connected peripherals need to have the same or higher ATEX approval.

Prevent
ignition source

The use of gas ballast and/or venting valves is only permitted if this would not normally, or only rarely, cause explosive mixtures within the device, or do so only for a short time.

- ⇒ If necessary vent with inert gas.

Information on the ATEX equipment category is also available on our website at: www.vacuubrand.com/.../Information-ATEX

2.7 Proper disposal

NOTICE

Risk of environmental damage due to incorrect disposal of the product.

- ⇒ Do not dispose your product in household waste!
Electronic components are subject to hazardous waste treatment and must only be disposed of by certified specialists.
- ⇒ Observe the national regulations for safe disposal and environmental protection.
- ⇒ Detailed information on the respective regulations can be obtained from your local administrative authority.

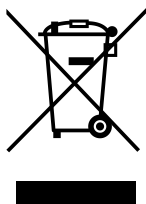

3 Product description

Pumping units in the PC 500/600 select series essentially consist of a diaphragm pump with electromagnetic and/or manual inlet valves, a VACUU·SELECT® vacuum controller, and a chiller with separator.

3.1 PC 511 VARIO select (schematic design)

→ Example
Side- and front view
PC 511 select

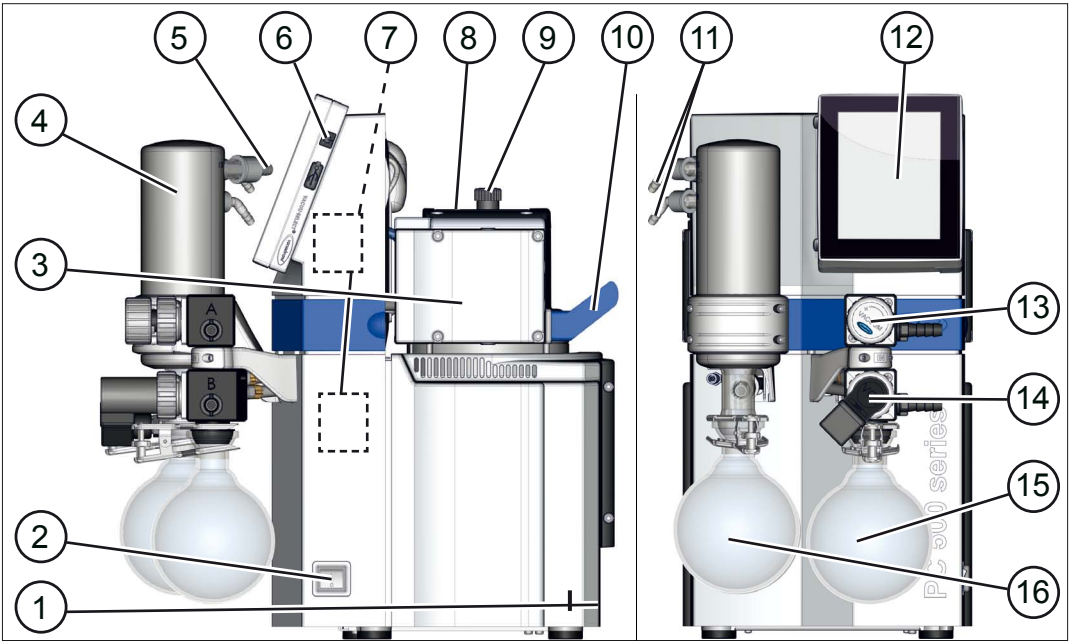

Meaning

1	Power connection, device fuse, VACUU·BUS, Ethernet
2	ON/OFF switch (rocker switch)
3	Chemistry diaphragm pump
4	Vapor condenser EK
5	Outlet, exhaust gas connection
6	Vacuum controller ON/OFF button
7	VACUU·SELECT® Sensor(s), mounted inside the pumping unit
8	Rating plate
9	Gas ballast valve
10	Handle
11	Coolant connections
12	VACUU·SELECT® operating panel, removable
13	Inlet – vacuum connection A (valve block), with manual flow control valve
14	Inlet – vacuum connection B (valve block), with electronically controlled valve
15	Round bottom flask AK at the inlet
16	Round bottom flask at the outlet

Inlet version at PC 510/PC 610

Inlet
PC 510 select
PC 610 select



17 Inlet – vacuum connection (distribution head), with electronically controlled valve

3.2 Chemistry pumping unit series

Overview of the PC 500/600 select chemistry pumping units

Overview
Chemistry pumping
units

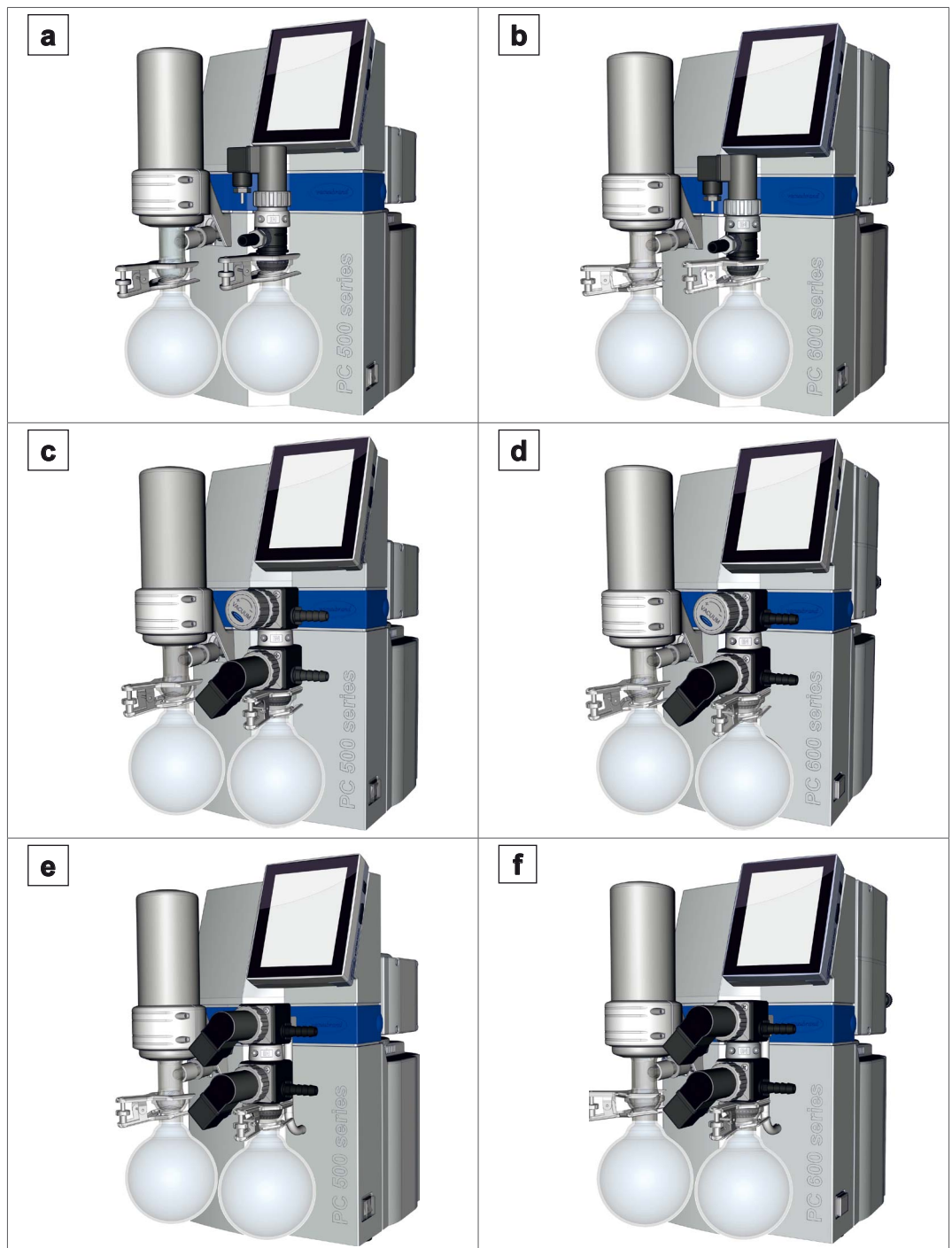

Meaning

Chemistry pumping unit	Pump head	Valve manually	Valve electrically
a PC 510 select	2		1x
b PC 610 select	4		1x
c PC 511 select	2	1x	1x
d PC 611 select	4	1x	1x
e PC 520 select	2		2x
f PC 620 select	4		2x

Product-specific abbreviations

Product-specific
abbreviations

- | | |
|----------------|--|
| AK | Separator flask, installed at inlet or outlet |
| EK | Vapor condenser, mounted at the outlet |
| PC | Chemistry pumping unit with type identification number |

3.3 Condensers and coolers

3.3.1 Separator at the inlet

Connection to separator flask

Connections at the
AK → example
PC 510/610 select

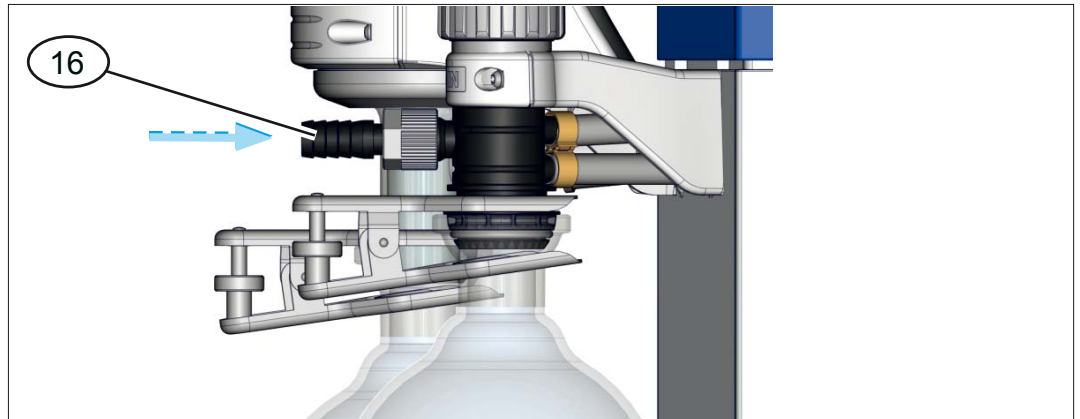

Meaning

16 Inlet connection vacuum IN

3.3.2 Condenser at the outlet

Connection and coolant at vapor condenser

Connections at the
EK



Meaning

- 5** Outlet connection EX
- 11.1** Outlet connection coolant EX
- 11.2** Inlet connection coolant IN, e. g, water

3.3.3 Examples of use

Local vacuum network

→ Example
Local vacuum
network

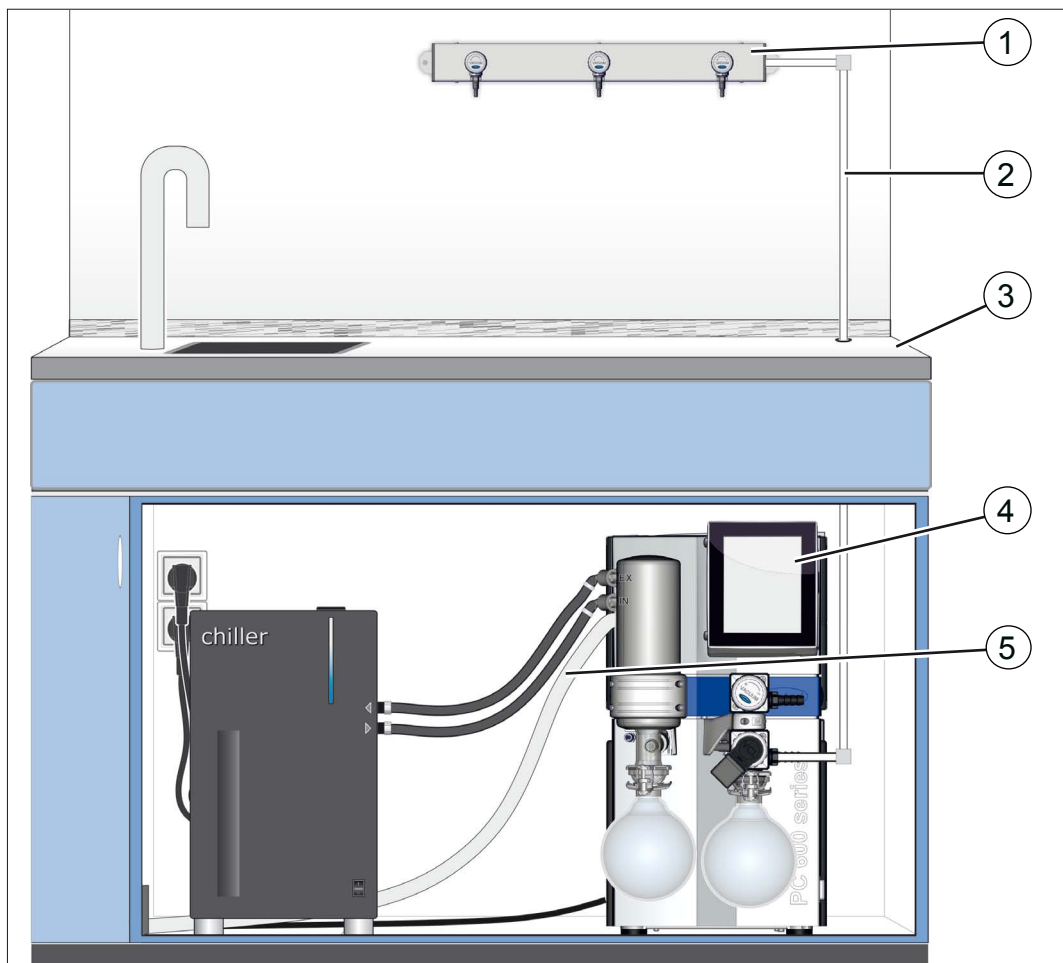

Meaning

- | | |
|---|--|
| 1 | Example of use: VACUU·LAN®, local area vacuum network with three valve modules |
| 2 | Vacuum hose* |
| 3 | Laboratory furniture |
| 4 | PC 611 select vacuum pumping unit |
| 5 | Exhaust hose (diverted into an exhaust hood) |

* permanent installed PTFE-tubings

Vacuum drying

→ Example
Vacuum drying

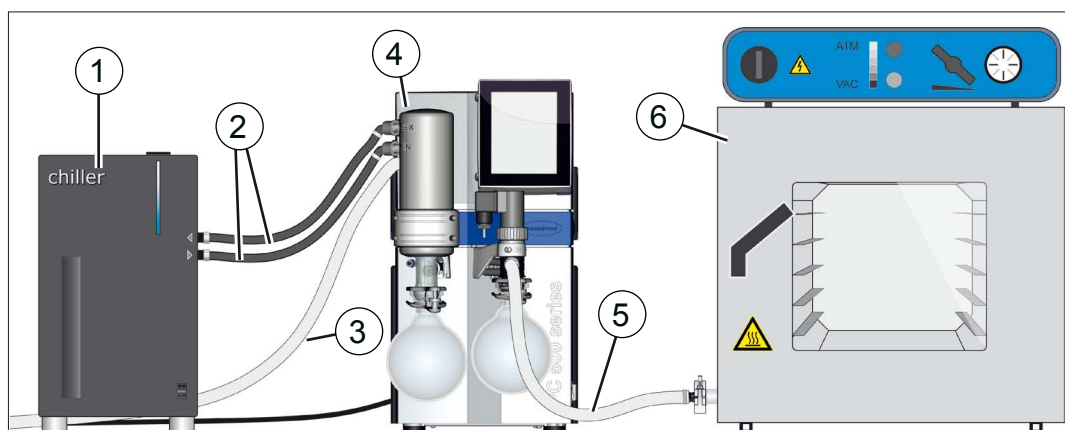

Meaning

- | | |
|---|--|
| 1 | Chiller |
| 2 | Coolant hoses |
| 3 | Outlet hose (diverted into a fume hood) |
| 4 | PC 510 select vacuum pumping unit |
| 5 | Vacuum hose |
| 6 | Example of use: Dryer cabinet |

4 Installation and connection

4.1 Transport

Products from **VACUUBRAND** are packed in sturdy, recyclable packaging.



The original packaging is accurately matched to your product for safe transport.

⇒ If possible, please keep the original packaging, e. g., for returning the product for repair.

Goods arrival

Check the shipment for transport damage and completeness.

⇒ Immediately report any transport damage in writing to the supplier.

Unpacking

→ Example
Pumping unit in
original packaging

Glass flask in
enclosed box

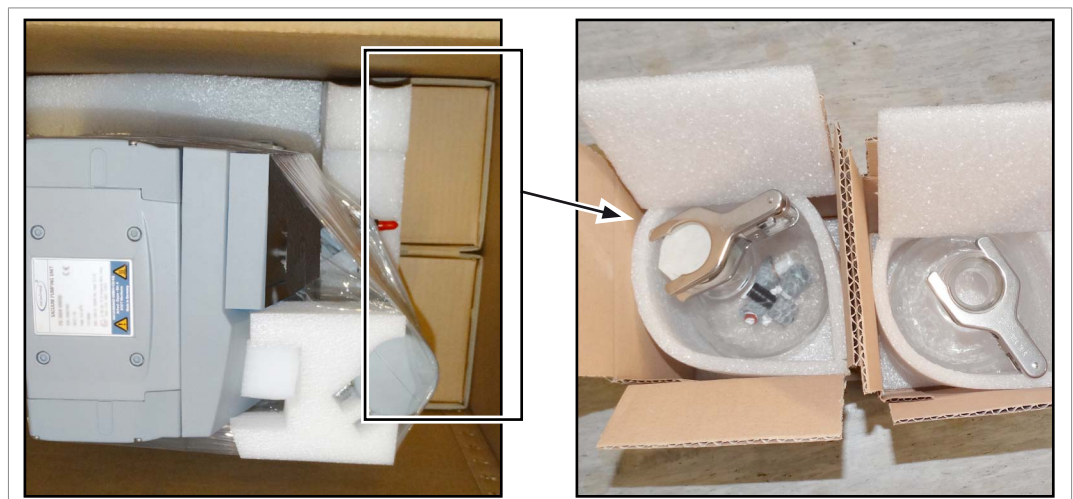

⇒ Remove the connections, such as hose nozzles and screw connections, from the glass flask.

⇒ Compare the scope of delivery with the delivery note.



⇒ Lift the unit out of the packaging by the recessed grips.

Transport the pumping unit

Transport the pumping unit

⇒ Hold the pumping unit at the handle with one hand and tip it slightly backwards. Then reach below the pumping unit in the front with the other hand and lift the pumping unit. Or: Use the recessed grips on the side, underneath the pump heads

Note: For transport, do not lift at the emission condenser/separator holders!

4.2 Installation

NOTICE

Condensate can damage the electronics.

A large temperature difference between the storage location and the installation location can cause condensation.

⇒ After goods receipt or storage, allow your vacuum device to acclimatize for at least 3-4 hours before initial use.

Check installation conditions

Check installation conditions

- The device is acclimatized.
- Ambient conditions have been observed and are within the limitation of use.
- The pump must have a stable and secure base without additional mechanical contact apart from the pump feet.

Installing the vacuum pump

⇒ Place the vacuum pump on a stable, nonvibrating, level, horizontal surface.

→ Example Sketch
Minimum distances
in laboratory
furniture

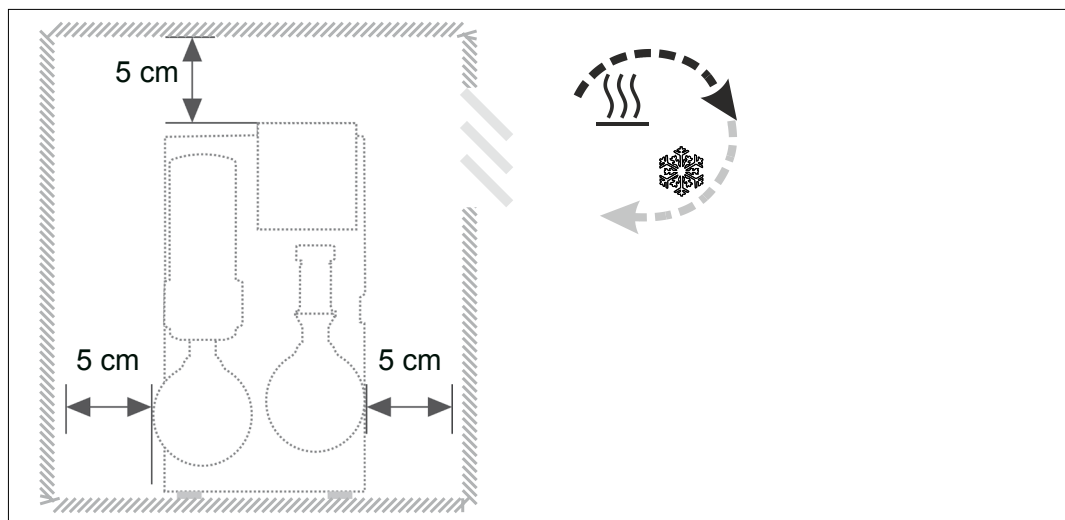

IMPORTANT!

- ⇒ When installing in laboratory furnishings, maintain a minimum distance of 5 cm (2 in.) from adjacent objects or surfaces.
- ⇒ Prevent heat accumulation and ensure sufficient air circulation, especially in closed housings.

Observe limitations of use

Observe limitation of use

Limitation of use		(US)
Ambient temperature	10–40 °C	50–104°F
Altitude, max.	2000 m über NHN	6562 ft above sea level
Minimum distance to adjacent parts	5 cm	2 in
Coolant circuit, max. pressure	3 bar	44 psi
Relative humidity	30–85 %, non condensing	
Protection type	IP 40/IK 08	
Prevent condensation or contamination from dust, liquids, or corrosive gases.		

IMPORTANT!

- ⇒ Note the IP protection class of the controller. IP protection is only guaranteed if the device is appropriately installed and correctly connected.
- ⇒ For connection also note the rating plate data and chapter **8.1.1 Technical data on page 74.**

4.3 Connection

All condensers of the pumping unit series have a vacuum connection and an exhaust gas connection. Perform the connection for your pumping unit as described in the examples below.

4.3.1 Vacuum connection (IN)

	<p>CAUTION</p>
	<p>Flexible vacuum hoses can contract during evacuation.</p> <p>Unsecured connected components can cause injuries or damage due to jerky movement (shrinkage) of the flexible vacuum hose. The vacuum hose can come loose.</p> <ul style="list-style-type: none"> ⇒ Fix the vacuum hose to the connections. ⇒ Fix connected components. ⇒ Measure the flexible vacuum hose such that you take the maximum shrinkage into account.

<p>NOTICE</p>	
<p>Foreign bodies in the suction line can damage the vacuum pump.</p> <p>⇒ Prevent particles, liquids or contaminants from being aspirated or being able to flow back.</p>	

IMPORTANT!

- ⇒ Use a sufficiently stable vacuum hose that is designed for the required vacuum range.
- ⇒ Connect hose lines as short as possible.
- ⇒ Connect hose lines in a gas-tight manner to the vacuum pump.

Connect vacuum hose

→ Example
Vacuum connection
at the inlet IN

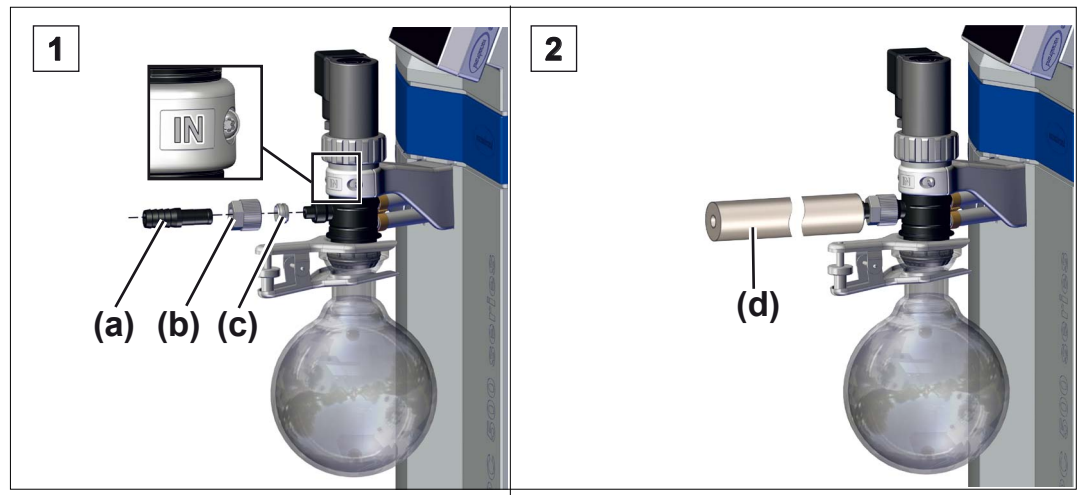

1. Connect the sealing ring **(c)**, the union nut **(b)** and the hose nozzle **(a)** as shown.
2. Push the vacuum hose **(d)** from the apparatus onto the hose nozzle and secure the vacuum hose, e. g., with a hose clamp.



Please observe the following points to get an optimal result:

- ⇒ Connect a vacuum line as short as possible with a cross-section as wide as possible.

4.3.2 Exhaust gas connection (EX)

	WARNING
	<p>Risk of bursting due to overpressure inside the exhaust tube.</p> <p>Inadmissibly high pressure in the exhaust gas line can cause the vacuum pump to burst or damage seals.</p> <ul style="list-style-type: none"> ⇒ The exhaust gas line (outlet, gas outlet) must always be clear and non-pressurized. ⇒ Always position the exhaust gas hose downwards or take measures to prevent condensate from flowing back into the vacuum pump. ⇒ Observe the maximum admissible pressures and pressure differences.

Connect exhaust gas hose

→ Example
Exhaust gas connection at the outlet EX

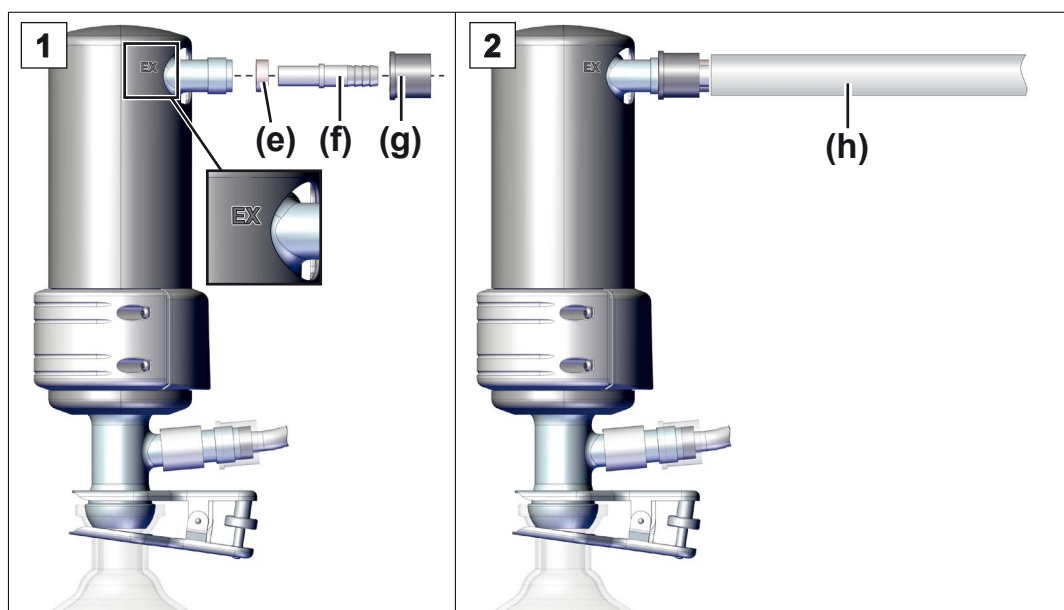

1. Connect the sealing ring (e), the hose nozzle (f) and the knurled nut (g) as shown and screw this onto the connection.
2. Push the exhaust gas hose (h) onto the hose nozzle and lay the hose, if necessary, in a fume hood. If necessary fix the vacuum hose, e. g., with a hose clamp.

4.3.3 Coolant connection at the condenser

Coolant connection
 IN = Feed line
 EX = outlet

A vapor condenser EK has a connection for coolant liquids. Water or the liquid from a chiller, for example, are suitable coolants.

IMPORTANT!

In a closed, in-house coolant circuit, the pressure should be limited to 3 bar (44 psi).

A cooling water valve may only be installed in the intake; the coolant drainage must be clear and non-pressurized.

Connect coolant

→ Example
 Coolant connection
 on the EK

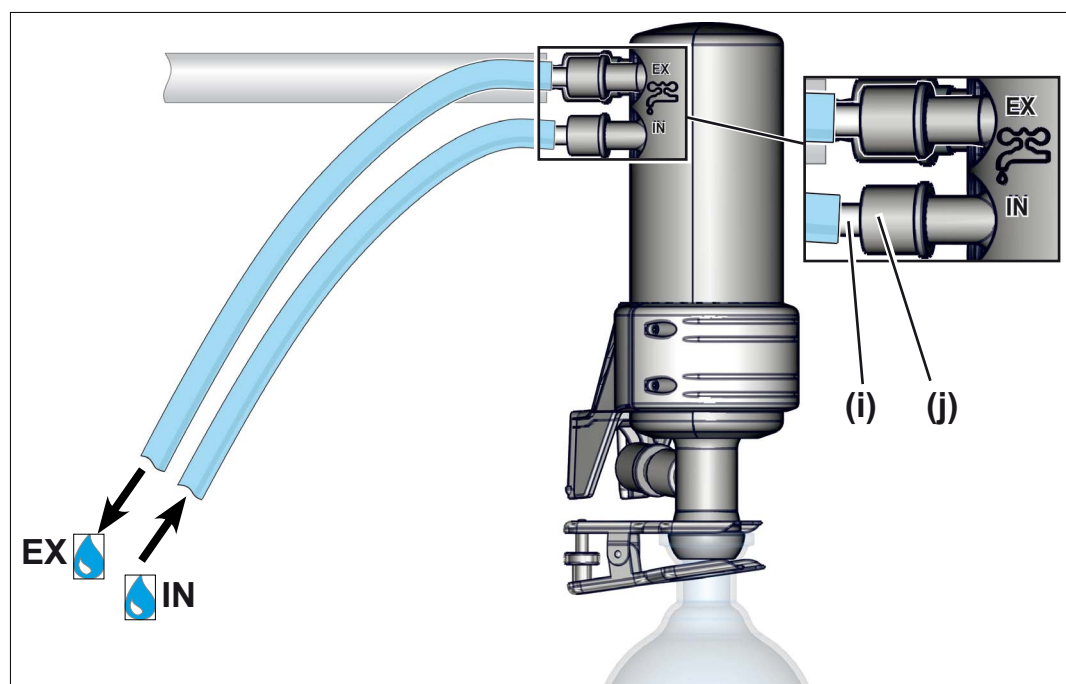

1. Fix both hose nozzles (i) to the condenser as shown using union nuts (j).
2. Fix the hoses for the coolant on the condenser as shown: IN = feed line, EX = outlet.
3. Fix the vacuum hoses, e. g., with hose clamps.

4.3.4 Venting connection

	DANGER
	<p>Risk of explosion due to venting with air.</p> <p>Depending on the application, venting can cause explosive mixtures to form or other hazardous situations to arise.</p> <ul style="list-style-type: none"> ⇒ Never vent processes with air which could form an explosive mixture. ⇒ In the case of flammable substances, use only inert gas for venting, e. g., nitrogen (max. 1,2 bar/17.5 psi abs.).

Venting with ambient air¹

Position VENT port

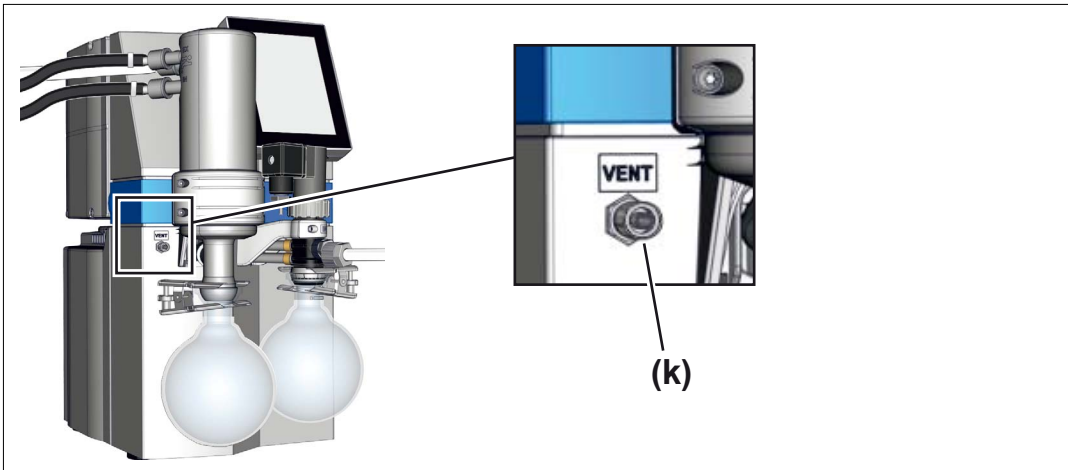

For venting with ambient air, nothing must be connected to the VENT port **(k)**.

¹ Only valid for sensors with integrated venting valve.

Venting with inert gas – connect venting valve²

Required connection material: Hose for hose nozzle (Ø 4 mm), e. g., silicone hose 4/6 mm.

Connection to VENT
port

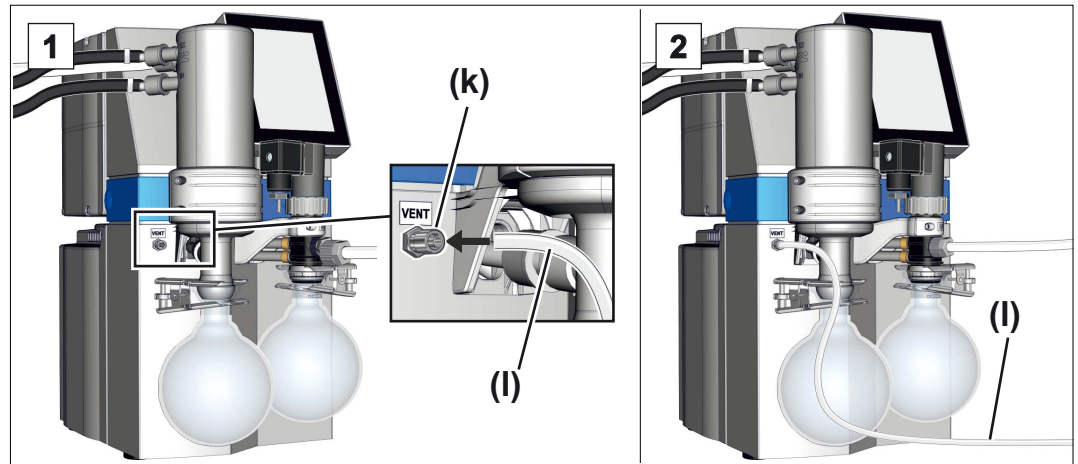

1. Push the hose (l) into the VENT port (k) and fix the tube with the knurled nut
2. Connect the hose (l) to inert gas (max. 1,2 bar/ 17.5 psi, abs.).

² Avoid overpressure.

4.3.5 Gas ballast (GB)

Use ambient air as gas ballast

→ Example
Position of gas
ballast valve

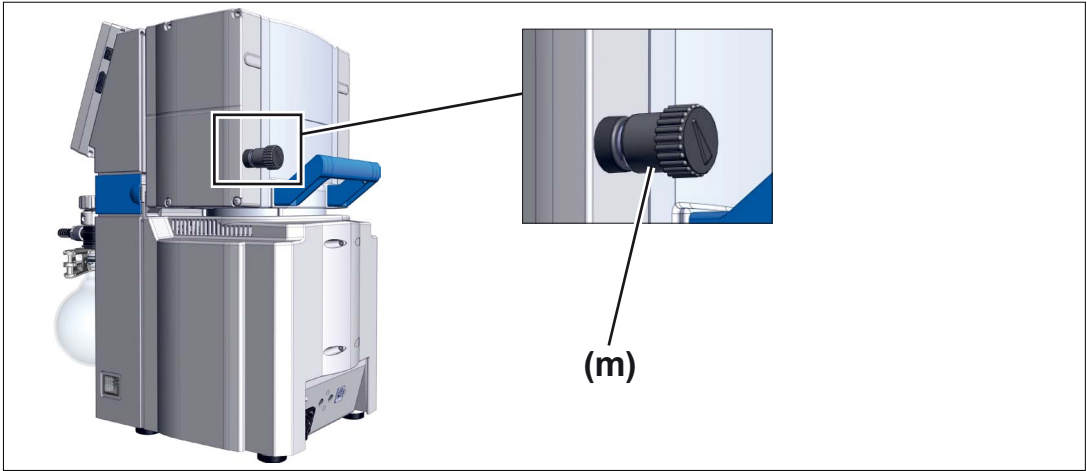

If ambient air is to be used as gas ballast, nothing needs to be connected at the pumping unit; gas ballast valve (m).
→ see also chapter 5.2.2 Operation with gas ballast on page 48

Use inert gas as gas ballast – OPTION

Prepare inert gas
connection (GB)

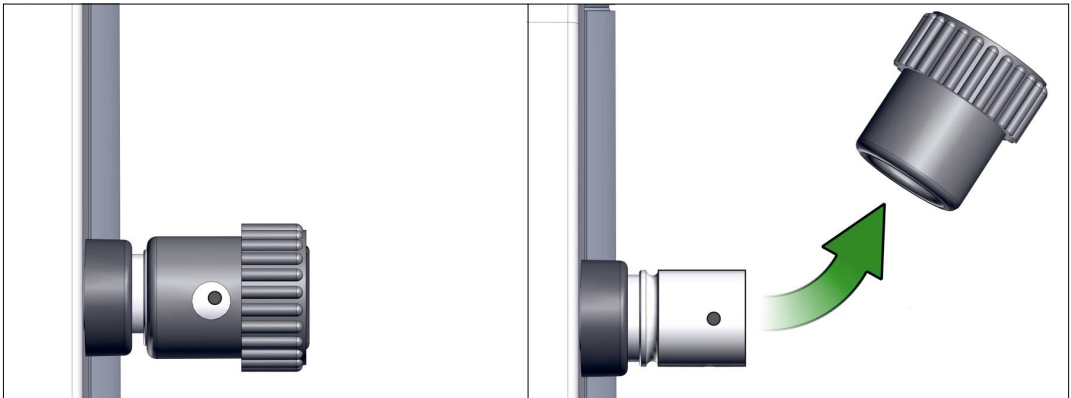

⇒ Remove the black gas ballast cap and connect a gas ballast adapter in its place.

i Connection options and adapter for hose nozzle or small flange are available on request.

4.3.6 Electrical connection

Connect pumping unit electrically

→ Example
Electrical connection
pumping unit

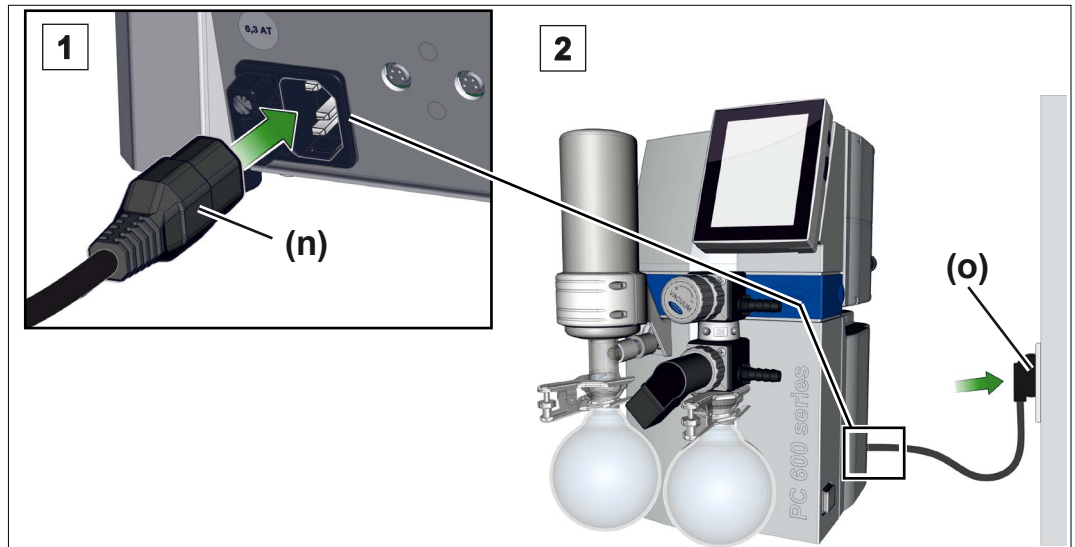

1. Plug the connector **(n)** on the power cable into the power connection of the vacuum pump.
2. Plug power plug **(o)** into the power outlet.
 Pumping unit connected electrically.

IMPORTANT!

⇒ Lay the power cable such that it cannot be damaged by sharp edges, chemicals, or hot surfaces.

Power connections with country code

Diagrams of
standard power
connections with
grounding contact

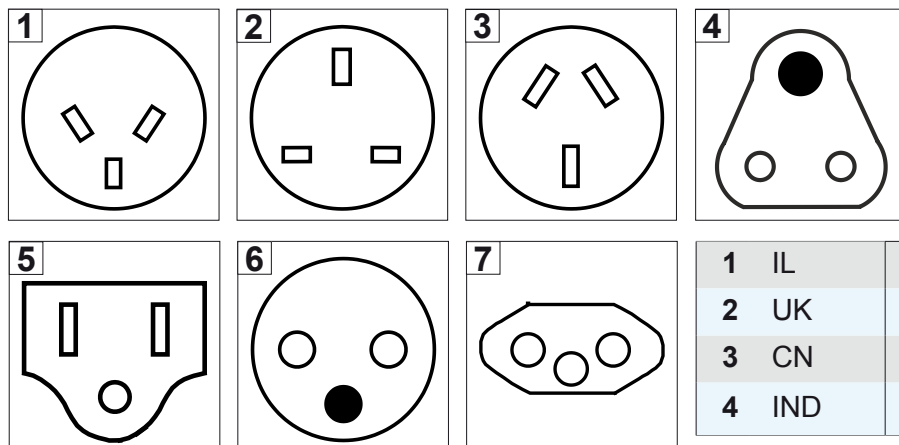

The vacuum pump is delivered ready for use with the appropriate power plug.

IMPORTANT!

- ⇒ Use the power plug which fits your power supply.
 - ⇒ Do not use multi-outlet power strips connected in series as the power connection.
-

5 Commissioning (operation)

5.1 Switch on

Switch on pumping unit

Switch on pumping unit

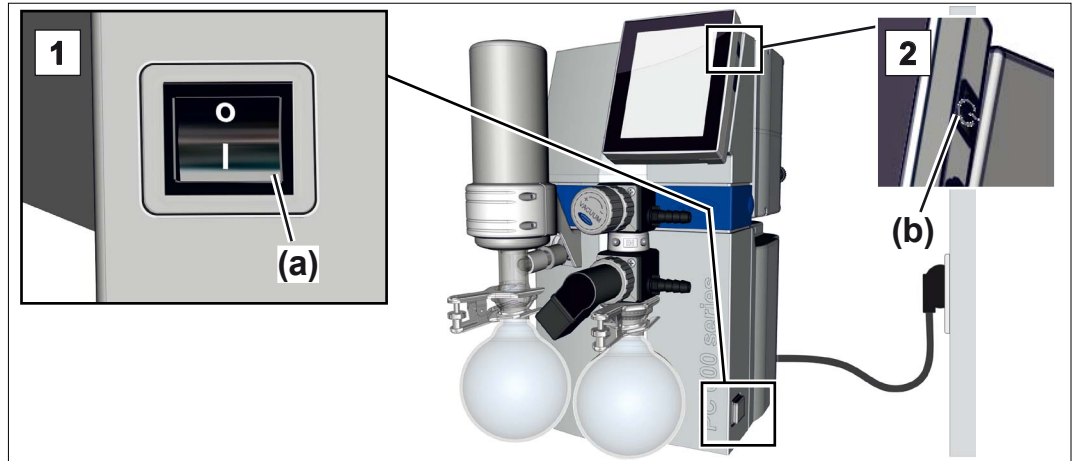

1. Switch the rocker switch (a) on – switch position I.
2. Press ON/OFF button (b) on the controller.
 - The start screen is displayed.
 - After approx. 30 seconds, the process screen appears with the operating elements in the controller display.

5.2 Operation

Operation by vacuum controller

Apart from the chapters Switch on and Switch off, this manual describes the mechanical structure of a pumping unit in the **PC 500/600 select** series.

The operation of the installed vacuum controller and its functions are described in its own manual **VACUU-SELECT**.

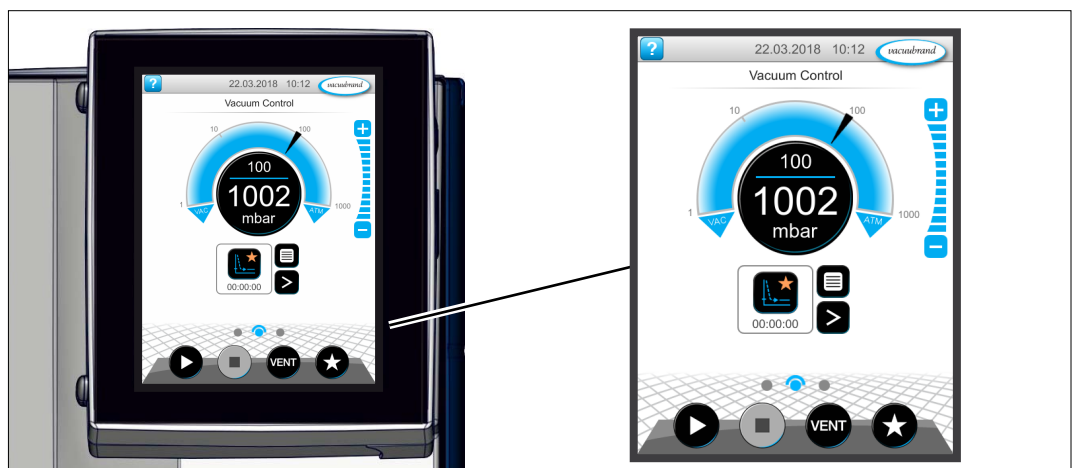

Process screen

Process screen vacuum controller

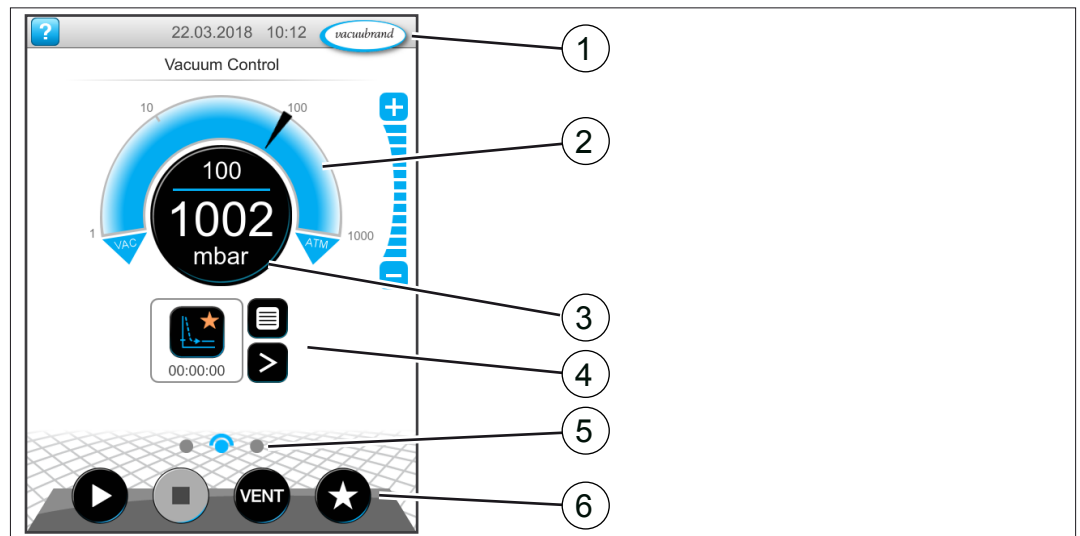

- 1 Status bar
- 2 Analogue pressure reading – pressure curve
- 3 Digital pressure reading – pressure value (target value, actual value, pressure unit)
- 4 Process screen with context functions
- 5 Screen navigation
- 6 Operating elements for control

Operating elements

Operating elements vacuum controller

Button		Function
active	Locked	
		Start ▶ Start application – only available on the process screen.
		Stop ▶ Stop application – always possible.
		VENT – vent the system (option) ▶ Press button < 2 sec = vent briefly; control continues.
		▶ Press button > 2 sec = vent to atmospheric pressure; vacuum pump is stopped.
		▶ Press button during venting = venting is stopped.
		Favorites ▶ View Favorites menu.

* Button is only displayed if venting valve is connected or activated.

5.2.1 Operation (→ see description of controller)

Start the vacuum controller

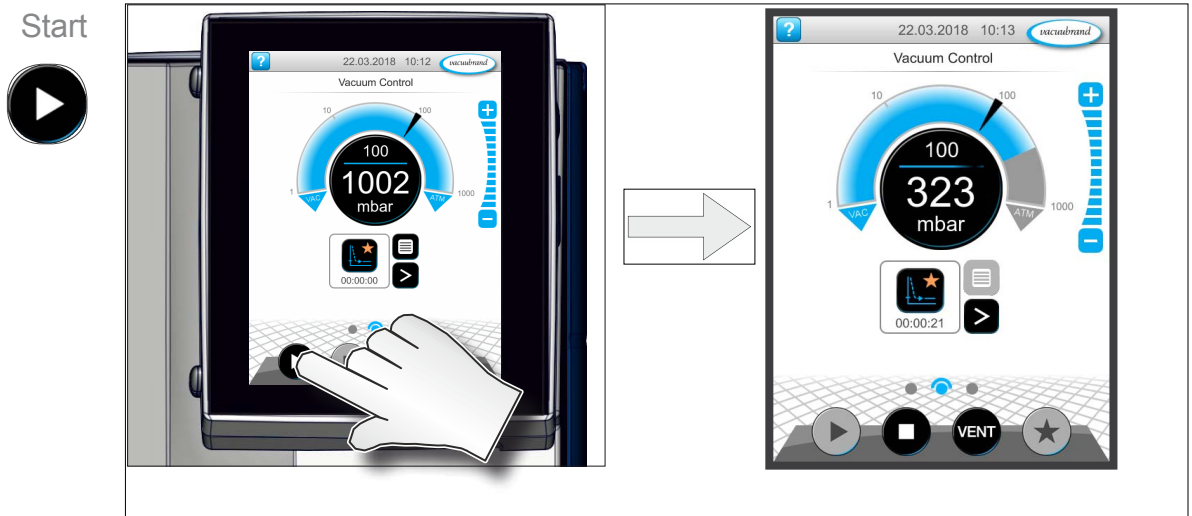

Stop the vacuum controller

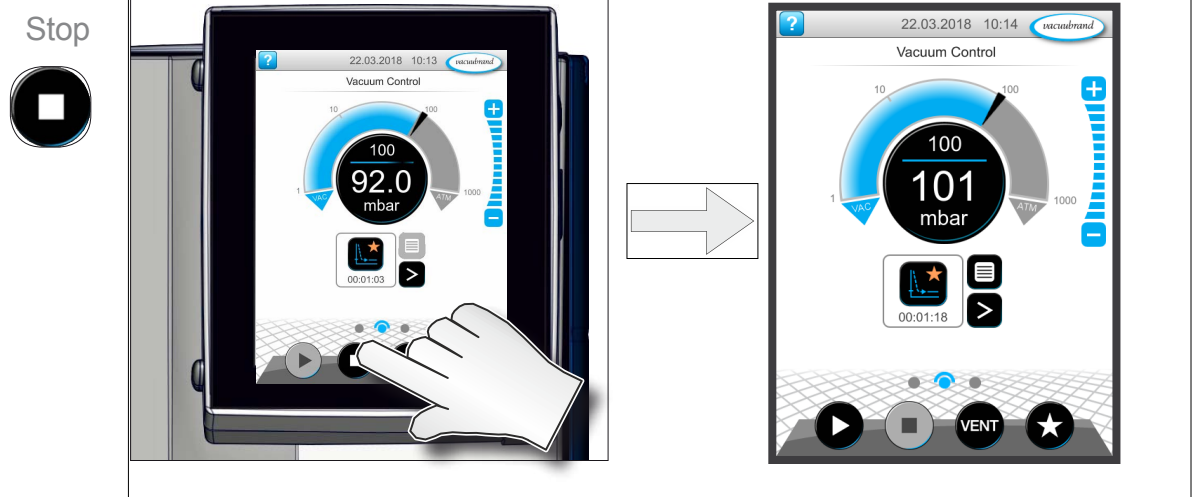

Venting

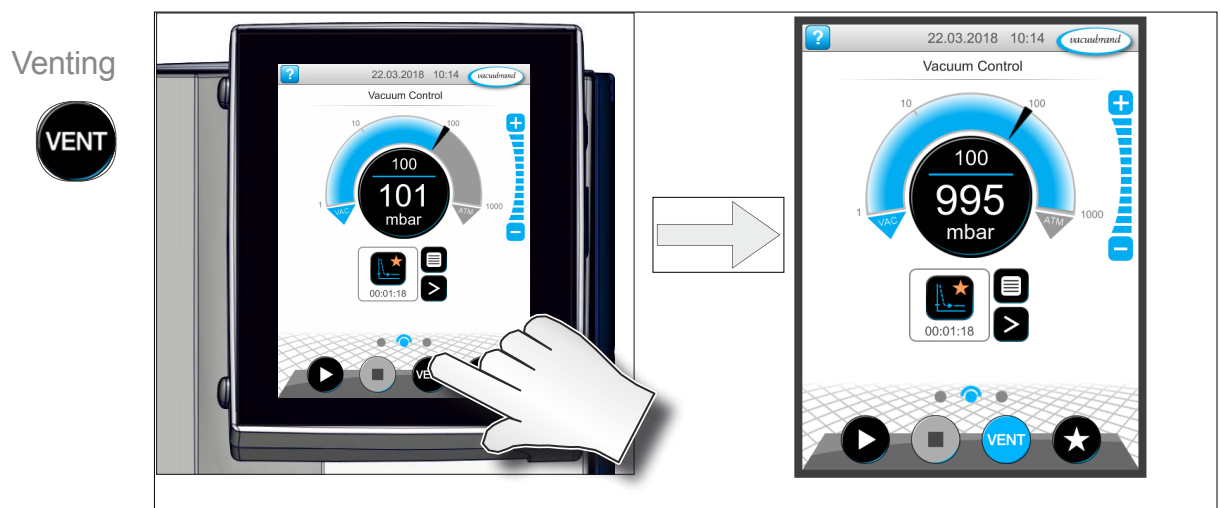

5.2.2 Operation with gas ballast

Meaning

The provision of gas ballast (= addition of gas) ensures that vapors do not condense inside the vacuum pump but are instead ejected from the pump. This makes it possible to pump larger amounts of condensable vapors and service lives are prolonged. The ultimate vacuum with gas ballast is slightly higher.

Open/close gas ballast valve

→ Example
Operate gas ballast
valve

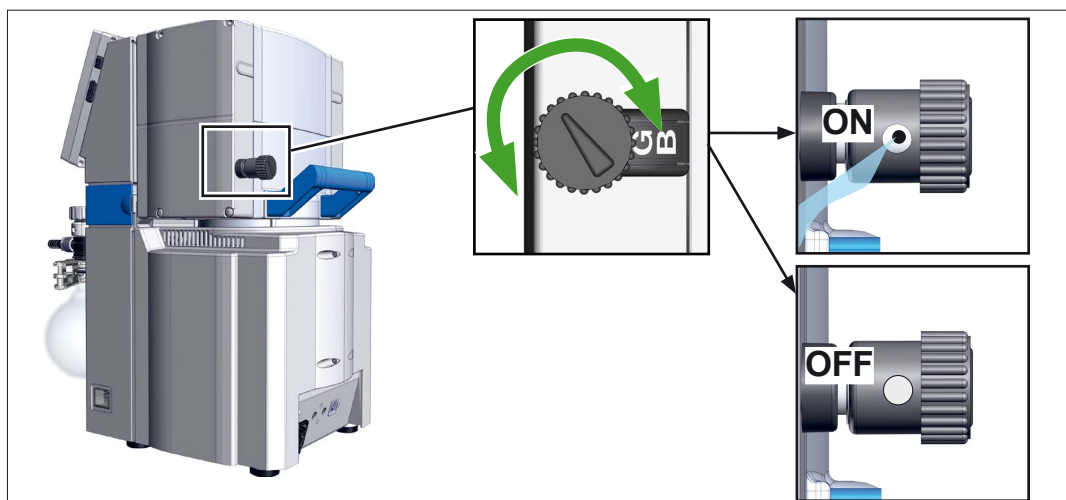

- ⇒ Turn the black gas ballast cap in any direction to open or close the gas ballast valve.
- ⇒ Evacuate condensable vapors, e. g., water vapor, solvents, etc. preferably only with the vacuum pump at operating temperature and with the gas ballast valve open.

IMPORTANT!

- ⇒ If necessary, connect inert gas as a gas ballast to prevent the formation of explosive mixtures.
- ⇒ Observe the admissible pressure at the gas ballast connection, max. 1,2 bar/17.5 psi abs.



If the gas volume in the vacuum pump is low, a gas ballast can be eliminated in these cases to increase the solvent recovery rate.

5.3 Decommissioning (switch off)

Take pumping unit out of operation

Switch-off pumping
unit

1. Stop the process and allow the pumping unit to run for approx. 30 minutes, with open gas ballast or open inlet (IN).
 - Condensate and media residues will be flushed out of the vacuum pump.

IMPORTANT! ⇒ Prevent deposits and rinse condensate out of the pump.

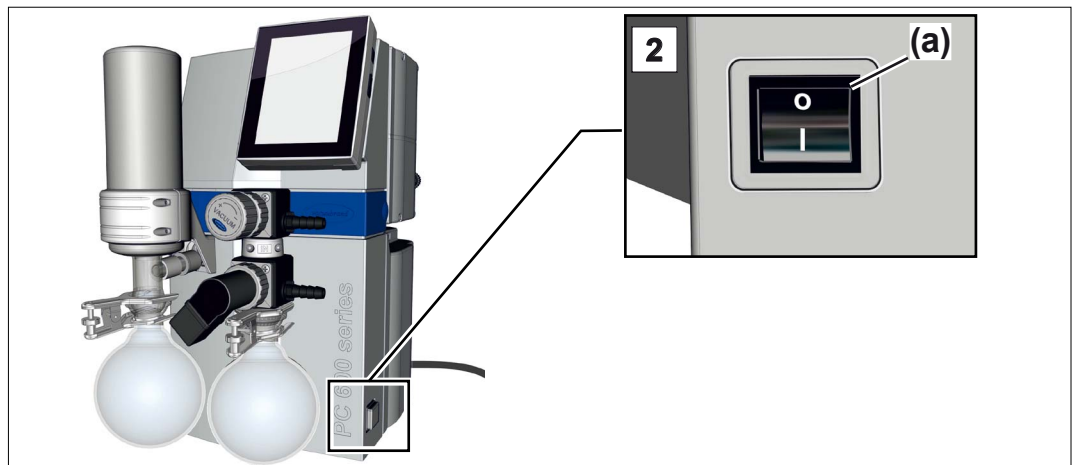

2. Switch the rocker switch **(a)** off – switch position **O**.
 - Pumping unit switched off.
3. Unplug the power plug.
4. Disconnect the pumping unit from the apparatus.
5. Empty the glass flasks.
6. Check the pumping unit for possible damage and pollution.

5.4 Storage

Store pumping unit

1. Clean the vacuum pumping unit when it is polluted.
2. Recommendation: Perform a preventive maintenance before storing the pumping unit. Especially if it ran more than 15000 operating hours
3. Close the suction and exhaust connections, e. g., with protection caps.
4. Package the pumping unit such that it is protected from dust; possibly enclose desiccants.
5. Store the vacuum pumping unit in a cool, dry location.

IMPORTANT!

If damaged parts are stored for operational reasons, these should be clearly identified as **not ready for use**.

6 Troubleshooting

6.1 Technical support

⇒ To identify errors and potential remedies, please refer to the troubleshooting table *Error – Cause – Remedy*.

For technical assistance or errors for which you require additional support, please contact your local distributor or our [Service Department](#)¹.



Operate the machine only when it is in proper working condition.

- ⇒ Observe the recommended maintenance intervals and thus ensure a functional system.
- ⇒ Send defective devices to our Service Department or your local supplier for repair!

6.2 Error – Cause – Remedy

Error	▶ Possible cause	✓ Remedy	Personnel
Readings deviate from the reference standard	<ul style="list-style-type: none"> ▶ Vacuum sensor dirty. ▶ Moisture in the sensor. ▶ Sensor defective. ▶ Sensor measures incorrectly. ▶ Vacuum sensor not correctly adjusted. 	<ul style="list-style-type: none"> ✓ Clean sensor measuring chamber. ✓ Allow sensor measuring chamber to dry, e. g., by pumping. ✓ Calibrate sensor with reference gauge. ✓ Replace defective components. 	Specialist
Sensor does not pass on measured value	<ul style="list-style-type: none"> ▶ No voltage applied. ▶ VACUU·BUS plug-in connection or cables defective or not connected. 	<ul style="list-style-type: none"> ✓ Check VACUU·BUS plug-in connection and cables to the controller. 	Operator
	<ul style="list-style-type: none"> ▶ Sensor defective. 	<ul style="list-style-type: none"> ✓ Replace defective components. 	Specialist





¹ -> Phone: +49 9342 808-5660, fax: +49 9342 808-5555, service@vacuubrand.com

Error	▶ Possible cause	✓ Remedy	Personnel
Venting valve does not operate	<ul style="list-style-type: none"> ▶ No voltage applied. ▶ VACUU·BUS plug-in connection or cables defective or not connected. ▶ Venting valve dirty. ▶ Venting valve in sensor defective. 	<ul style="list-style-type: none"> ✓ Check VACUU·BUS plug-in connection and cables to the controller. ✓ Clean venting valve. ✓ If necessary, use another external venting valve. 	Specialist
Vacuum pump does not start.	<ul style="list-style-type: none"> ▶ Overpressure in the outlet (exhaust) line. ▶ Condensation in the vacuum pump. 	<ul style="list-style-type: none"> ✓ Open up exhaust gas line. ✓ Ensure a clear passage. ✓ Flushing: Operate vacuum pump briefly with open suction nozzle. 	Operator
	<ul style="list-style-type: none"> ▶ Pumping unit switched off. ▶ Power plug not correctly plugged in or pulled out. ▶ VACUU·BUS plug-in connection or cables defective or not connected. 	<ul style="list-style-type: none"> ✓ Switch pumping unit on using rocker switch. ✓ Check power supply and cable. ✓ Check VACUU·BUS plug-in connection and cables to the controller. 	Operator
	<ul style="list-style-type: none"> ▶ Motor overloaded. ▶ Thermal protection triggered. 	<ul style="list-style-type: none"> ✓ Allow the motor to cool down. ✓ Clear error manually: → Unplug pumping unit from the power supply → Eliminate cause of error → Switch pumping unit back on 	Specialist
No or very little suction power	<ul style="list-style-type: none"> ▶ Leak in the suction line or in the apparatus. ▶ Separator flask not mounted properly. 	<ul style="list-style-type: none"> ✓ Check suction line and apparatus for possible leaks. ✓ Check separator flask and its correctly fixation. ✓ Check apparatus for leaks. 	Operator

Error	▶ Possible cause	✓ Remedy	Personnel
	▶ Vacuum line too long or cross-section too small.	✓ Use a shorter vacuum line with a larger cross-section.	resp. Specialist
	▶ Condensate inside the vacuum pump.	✓ Allow vacuum pump to run for a few minutes with the suction nozzle open.	Operator
	▶ Deposits inside the vacuum pump	✓ Clean and check pump heads.	Specialist
	▶ Diaphragms or valves defective.	✓ Replace defective parts.	Specialist
	▶ High level of vapor generated in the process.	✓ Check process parameter.	Specialist
	▶ High level of vapor generated in the process.	✓ Check settings at the controller.	Operator
	▶ Gas ballast open	✓ Close gas ballast	Operator
	▶ Gas ballast cap porous or no longer present.	✓ Check gas ballast cap. ✓ Replace defective components.	Operator
	▶ Pump too hot.	✓ Allow the pump to cool down. Determine and eliminate cause of the overheating.	resp. specialist
No display	▶ Pumping unit switched off. ▶ Power plug not correctly plugged in or pulled out. ▶ VACUU·BUS plug-in connection or cables defective or not connected. ▶ Controller switched off or defective.	✓ Switch pumping unit on using rocker switch. ✓ Check power supply and cable. ✓ Check VACUU·BUS plug-in connection and cables to the controller. ✓ Switch on controller. ✓ Replace defective components.	Operator
Loud operating noises	▶ No hose installed.	✓ Check hose and install it right.	Operator

Error	▶ Possible cause	✓ Remedy	Personnel
	<ul style="list-style-type: none"> ▶ Ball bearing defective. ▶ Outlet pipe open. ▶ Glass flask on EK missing. ▶ Diaphragm tear or diaphragm clamping disc loose. 	<ul style="list-style-type: none"> ✓ Service the vacuum pump and replace defective parts or send in the device. ✓ Check exhaust gas line connections. ✓ Connect the outlet pipe to an exhaust system, e. g., fume hood. ✓ Assemble glass flask. 	Specialist
Condenser (cooler) defective	▶ Mechanically damaged.	✓ Send in.	resp. Specialist

7 Cleaning and maintenance

	WARNING
	<p>Danger due to electrical voltage.</p> <ul style="list-style-type: none"> ⇒ Switch the device off before cleaning or maintenance work. ⇒ Unplug the power plug from the socket.
	<p>Danger due to outdated motor condensers.</p> <p>Condensers can become hot and possibly melt. There can also rarely be darting flames.</p> <ul style="list-style-type: none"> ⇒ Regularly check motor condensers (measure capacity, estimate operating hours). Typical service life is 10,000 to 40,000 operating hours, depending on operating conditions (temperature, engine load, ...). ⇒ Condensers must be replaced by an electrician.
	<p>Risk from contaminated parts.</p> <p>Pumping hazardous media can result in hazardous substances adhering to internal parts of the pump.</p> <ul style="list-style-type: none"> ⇒ Wear your personal protective equipment, e. g., protective gloves, eye protection and, if necessary, respiratory protection. ⇒ Decontaminate the vacuum pump before opening it. If necessary have decontamination carried out by an external service provider. ⇒ Take safety precautions according to your instructions for handling hazardous substances.

NOTICE

Damage possible if work is performed incorrectly.

- ⇒ Have maintenance work performed by a trained professional or at least by a trained person.
- ⇒ Recommendation: Before carrying out maintenance for the first time, please read through all the instructions to get an overview of the required service work.

7.1 Information on service work

Recommended maintenance intervals

Maintenance intervals*	If required	15000 h
Replace the diaphragms		X
Replace the valves		X
Replace O-rings		X
Clean or replace molded PTFE hose	X	
Replace pressure relief valve on EK	X	
Cleaning Pumping unit	X	

* Recommended maintenance interval after hours of operation and under normal operating conditions; depending on the environment and area of application, we advise performing cleaning and maintenance as needed.

Recommended aids

→ Example
Recommended aids
for cleaning and
maintenance



No.	Auxiliary materials
1	Round bottom flask stand
2	Protective gloves
3	Chemically-resistant vessel + funnel

IMPORTANT!

⇒ Always wear your personal protective equipment when performing activities which may bring you into contact with hazardous substances.

Tools needed for maintenance

→ Example
Tools

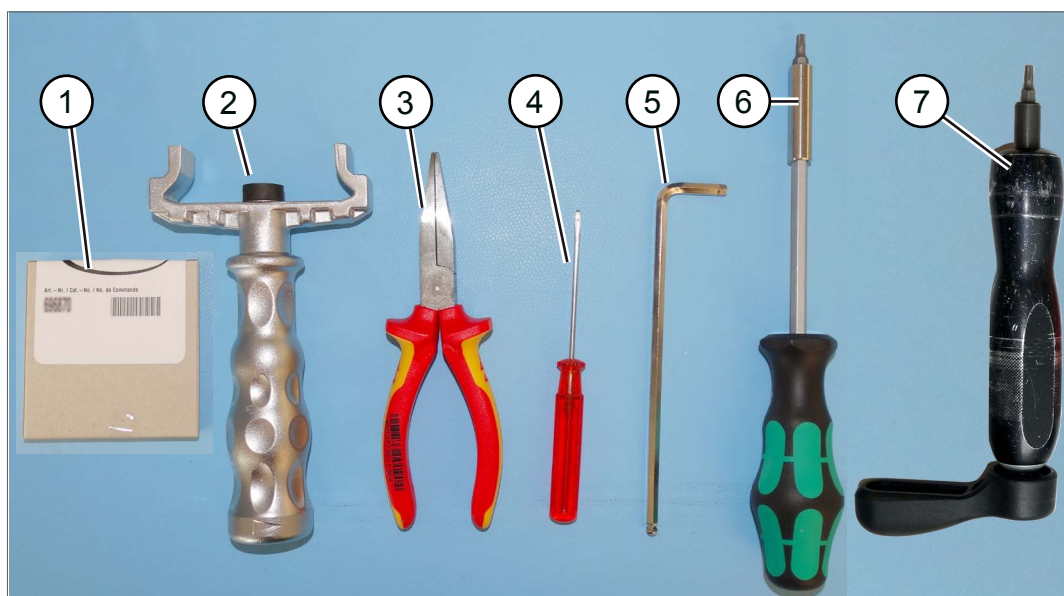

No.	Tool	Size
1	Service kit Service kit MZ 2C NT #20696869 <i>or</i> Service kit MD 4C #20696870	
2	Diaphragm wrench #20636554	SW66
3	Flat nose pliers Close hose clamps	
4	Flat-head screwdriver Open hose clamps	Size 1
5	Hex key Screw fittings, head cover	Size 5
6	*Torx screwdriver Screw fittings, counterhold EK Screw fittings, head cover Loosen/secure clamping brackets Screw connection gas ballast	TX10 TX20 TX20 TX20
7	Torque wrench, adjustable 2–12 Nm	

* In the example here with bit support

7.2 Cleaning

IMPORTANT!

This chapter does not contain descriptions for decontamination of the product. This chapter describes simple measures for cleaning and care.

⇒ Before cleaning, switch off the Pumping unit.

7.2.1 Housing surface



Clean surface

Clean dirty surfaces with a clean, slightly damp cloth. We recommend using water or mild soapy water to moisten the cloth.

7.2.2 Empty the glass flask

Remove and empty the glass flask

→ Example
Empty the glass
flask

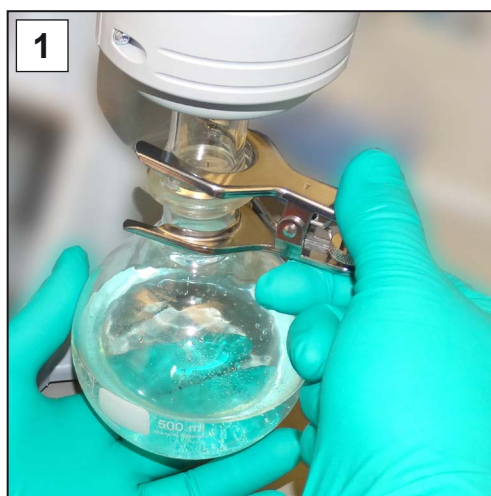

1. Open the joint clamp and remove the glass flask.

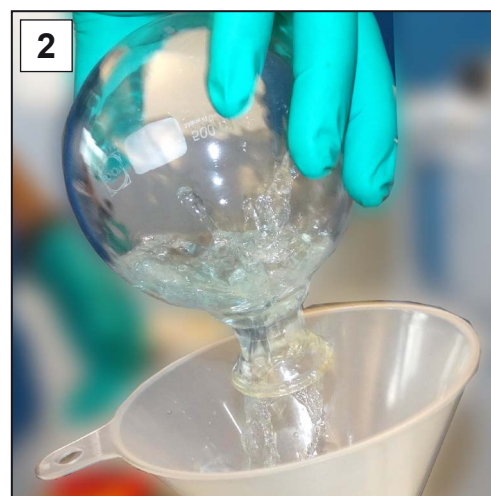

2. Empty the glass flask into a suitable container, e. g., chemical-resistant canister.

3. Then secure the glass flask to the condenser again using the joint clamp.



Depending on the application, the liquid collected can either be retreated or professionally disposed of.

7.2.3 Clean or replace molded PTFE hoses

Maintenance provides the opportunity to check the components of the Pumping unit, including the hoses.

- ⇒ Clean the inside of very dirty molded hoses, e. g., using a pipe cleaner or similar.
- ⇒ Replace brittle and defective molded hoses.

7.3 Vacuum pump maintenance

7.3.1 Maintenance items

Items that require maintenance

→ Example
Maintenance of the
pump heads
A = 4-headed
B = 2-headed

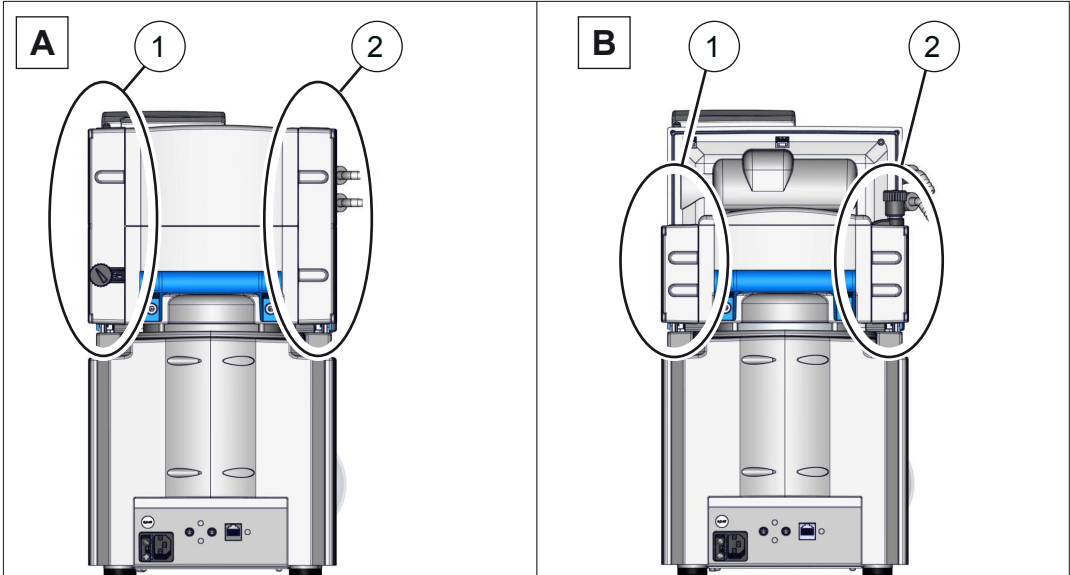

Maintenance items

- 1 Pump heads, power connection side
- 2 Pump heads, vapor condenser side (EK)

IMPORTANT!

- ⇒ Perform maintenance of the pump heads one after the other
- ⇒ In the case of the pump heads, always change the diaphragms and valves completely, as shown in the image description for pump head **(1A)**.

i Straightforward maintenance due to split work steps.

- ⇒ On one pump head pair, first replace the diaphragms.
- ⇒ Then change the inlet/outlet valves.
- ⇒ Repeat these steps on the next pump head pair.

Exploded drawing of pump head (example)

→ Example
Exploded-drawing
pump head PC 610

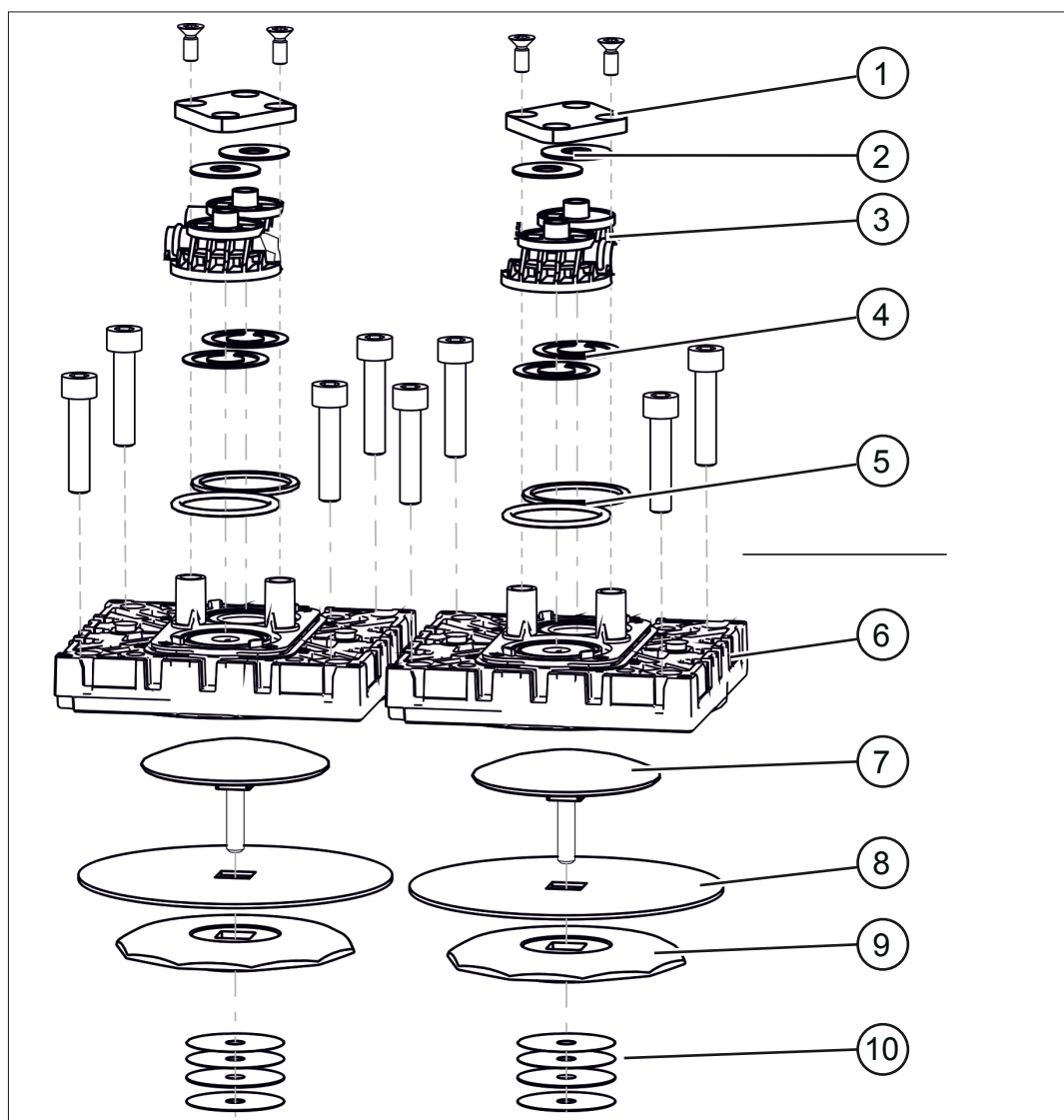
**Valve maintenance**

- 1 Clamping claw + screw fittings
- 2 Disc springs
- 3 Valve terminals
- 4 Valves
- 5 O-rings size 26 x 2

Diaphragm maintenance

- 6 Head cover + screw fittings
- 7 Diaphragm clamping disc with square-head screw
- 8 Diaphragm
- 9 Diaphragm support disc
- 10 Spacer discs, max. 4 per pump head

7.3.2 Change the diaphragms and valves

Preparation

→ Example
Prepare
maintenance



1. Switch the Pumping unit off and unplug the power plug.



2. Remove the glass flask from the EK as well as the connected hoses.

→ Example
Disassemble EK
(optionally)



3. Unscrew the screws from the counterholder;
Torx screwdriver TX10

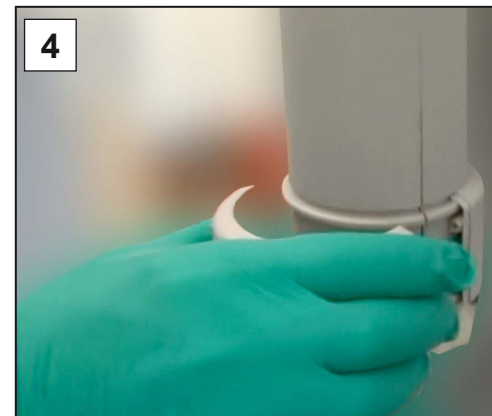

4. Remove the counterholder and lay it aside together with the screws.



5. Unscrew the knurled nuts, pull off the molded hose, and remove the cooler.



6. Set the chiller down securely so that no liquid can escape.

Disassemble the device and housing sections

→ Example
Disassemble
housing sections



1. Unscrew the screws from the head cover cowling; Torx screwdriver TX20.



2. Remove the head cover cowling and set it aside.



3. Open the hose clips on the outer hoses. Flat-head screwdriver 1.



4. Pull off the molded hoses.

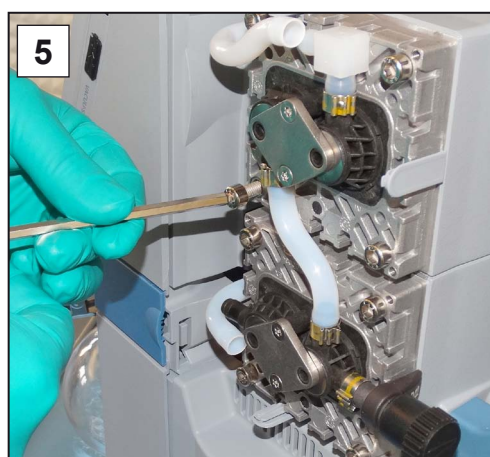

5. Unscrew the socket head screws from the head covers. Hex key size 5.



6. Lift the pump head pair along with all the screwings of the vacuum pump.

Replace the diaphragms

→ Example
Diaphragm
replacement



1. Press lightly on one of the diaphragm clamping discs.

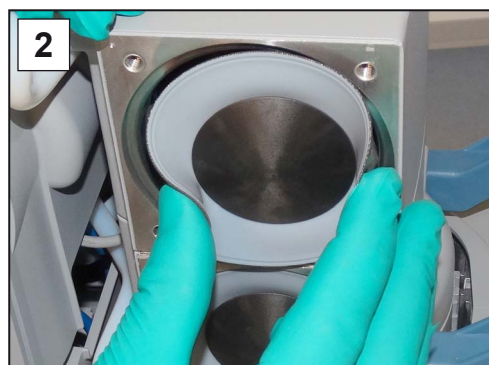

2. Lift the diaphragm upwards on either side.

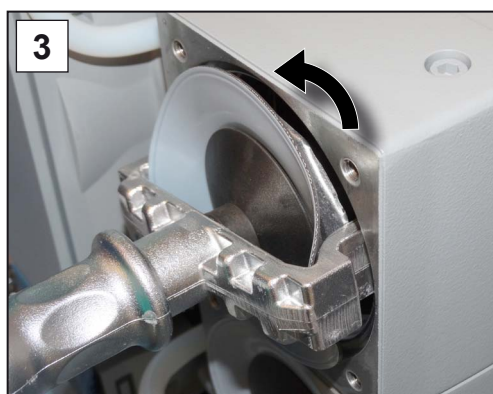

3. Carefully position the diaphragm wrench on the diaphragm support disc and unscrew the assembly with the diaphragm wrench attached.



4. Lift the diaphragm, along with all the parts, out of the vacuum pump.
If the spacer discs adhere to the connecting rod, remove them carefully.



IMPORTANT!

- ⇒ Never drop spacer discs into the aluminum housing.
- ⇒ Keep the spacer discs. It is essential to reinsert the same number of spacer discs.

→ Example
Diaphragm
replacement

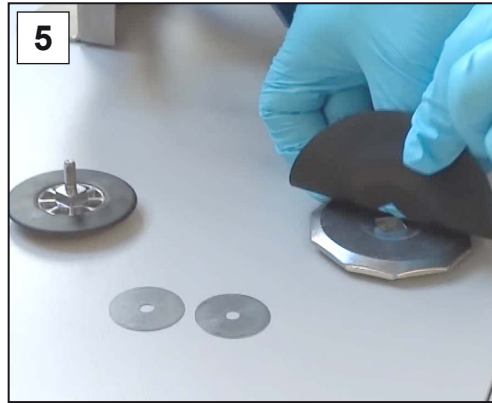

5. Pull out the diaphragm clamping disc and remove the used diaphragm.



6. Place the new diaphragm over the square head of the clamping disc.

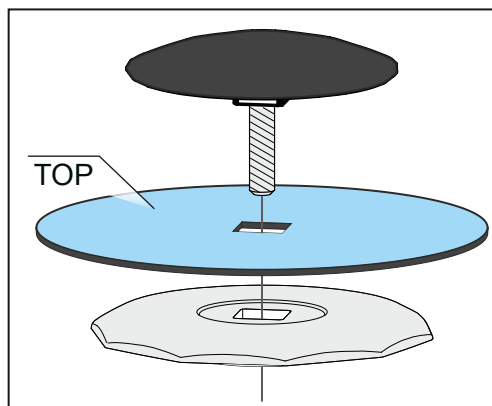

IMPORTANT!

- ⇒ Ensure that the diaphragm is inserted correctly, with the coated, light-colored side facing upwards.
- ⇒ Pay special attention to correct positioning on the square head.



7. Place all spacer discs on the thread pin.



8. Fix the diaphragm assembly inside the diaphragm wrench.

→ Example
Diaphragm
replacement



9. Hold the spacer discs firmly and place all the components carefully on the connecting rod thread.



10. Initially tighten the assembly with the diaphragm wrench by hand.



11. Then position a torque wrench with socket head bit on the diaphragm wrench and tighten the assembly to 6 Nm.

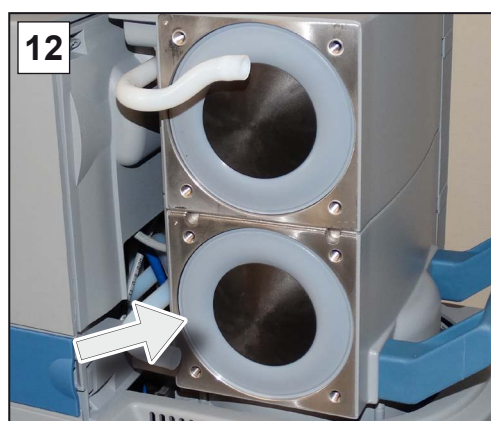

12. Repeat the steps for the second diaphragm.

Replace the valves

→ Example
Valve replacement

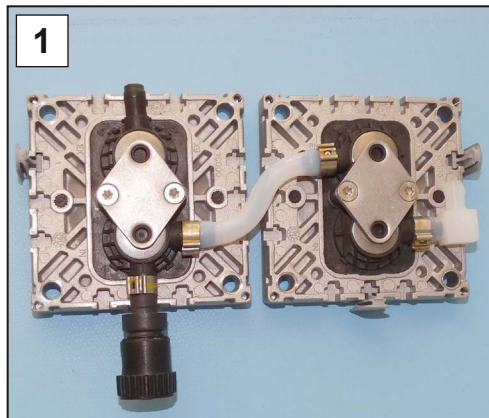

1. Take the pump head pair which you had set aside.

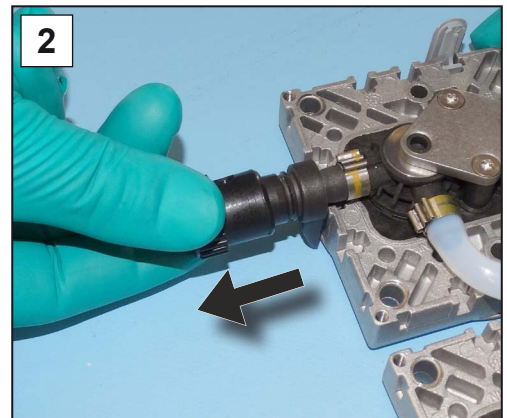

2. Remove the cap from the gas ballast.

Figure 2–4 optional
description, since
gas ballast mounted
only on one side

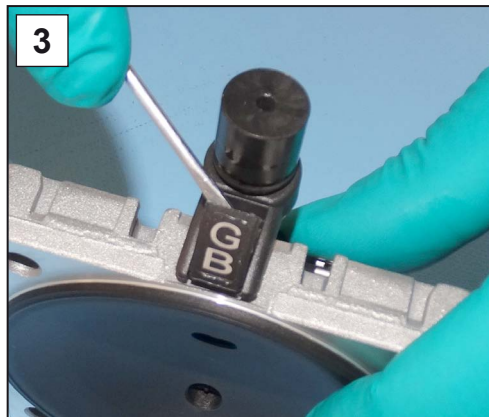

3. Carefully pry off the cover.

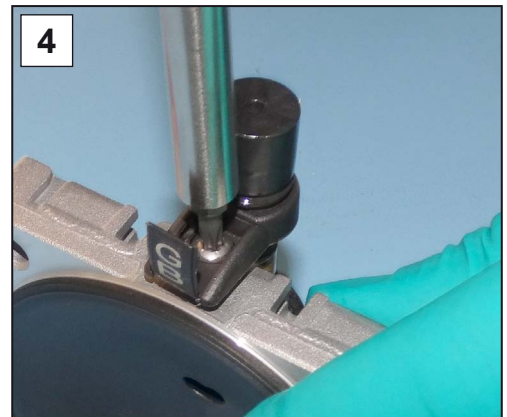

4. Unscrew the screw connection;
Torx screwdriver TX20.

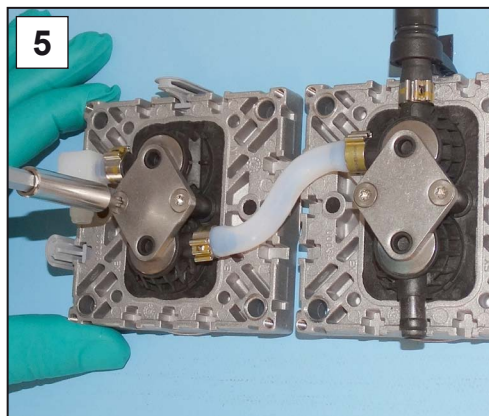

5. Unscrew the screws from the
counterholder; Torx screw-
driver TX20

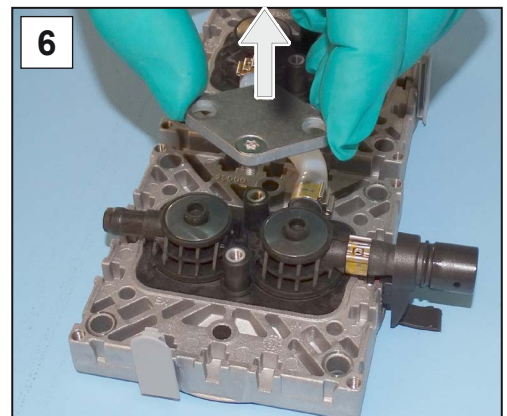

6. Remove the clamping brackets
from the valve terminals.

→ Example
Valve replacement

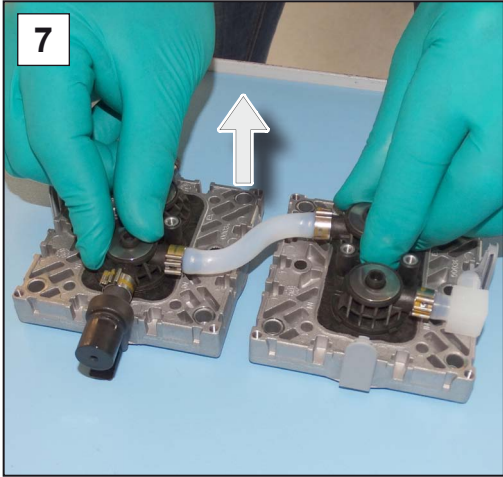

7. Remove the valve terminals with the disc springs.

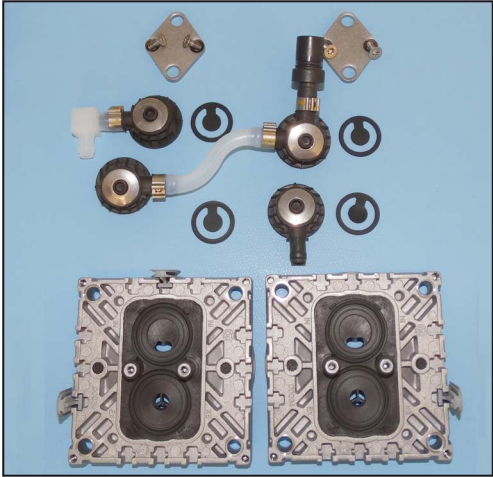

Top view: Valve terminals, valves and pump head pair.

NOTICE

Valves can adhere to the underside of a valve terminal.

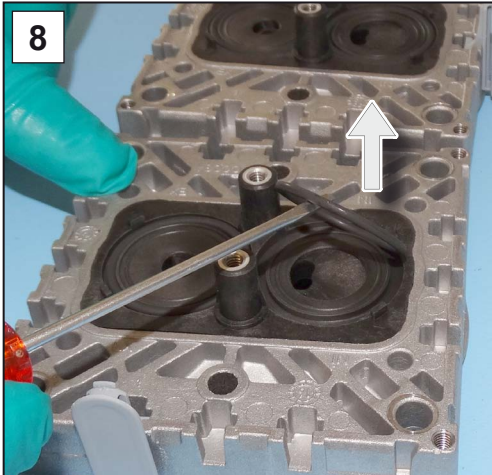

8. Carefully remove the used O-rings and valves.

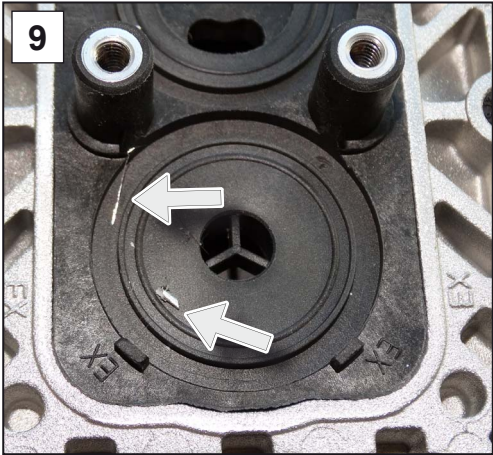

9. Check the surfaces for dirt.

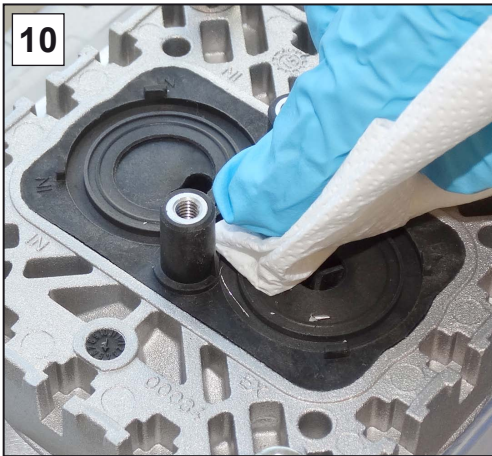

10. Clean dirty surfaces carefully.

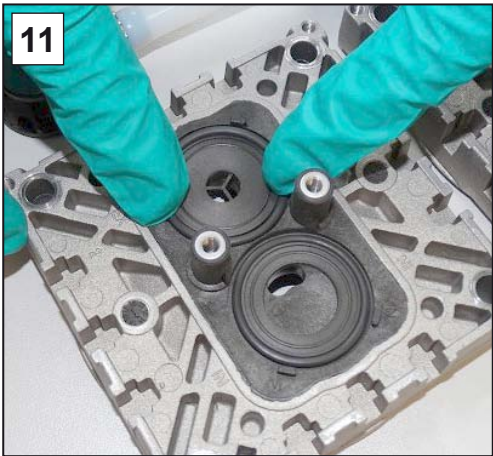

11. Insert the new O-rings into the grooves.

→ Example
Valve replacement

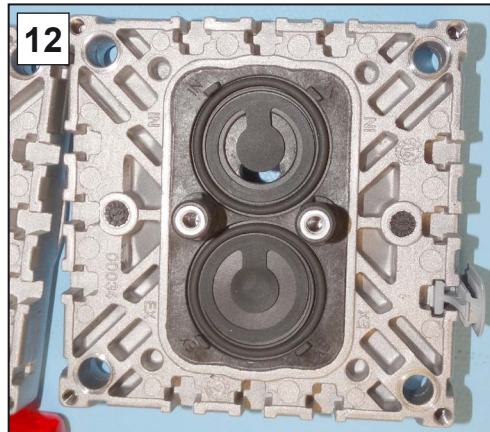

12. Place the new valves on top and align them.

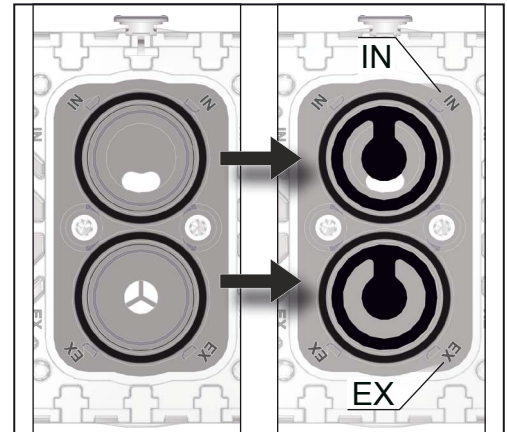

Cutout view from above: Correct valve positioning. IN = Inlet (inlet)
EX = Exhaust (outlet)

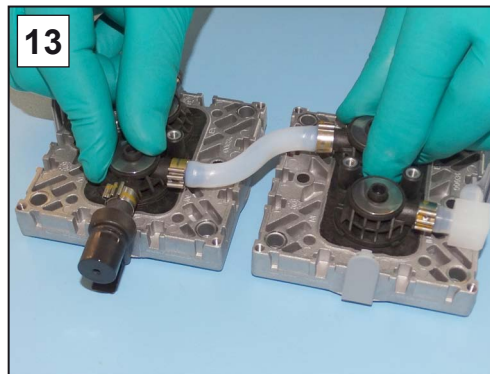

13. Place both valve terminals with the disc springs on the pump heads.

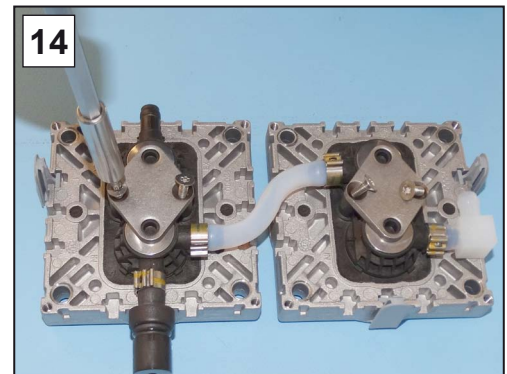

14. Place the clamping brackets on the valve terminals and tighten the screw fittings by hand.

Assemble the device and housing sections

Before restarting the pumping unit, all parts of the device and housing which had been removed must be fixed back in place.

→ Example
Assemble device
and housing parts



1. Carefully press the diaphragms centrally into the housing opening, ensuring they are flush with it.



2. Hold the pump head pair at the vacuum pump and wind in the screw fittings; hex key size 5.

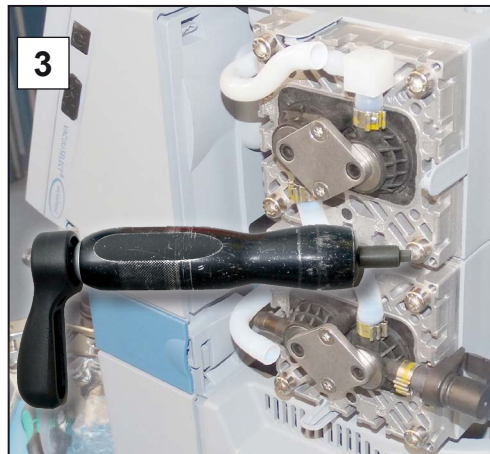

3. Tighten the screw connections crosswise using a torque wrench with 12 Nm.

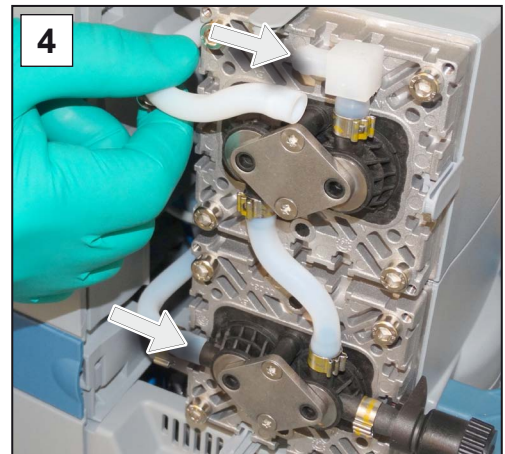

4. Slide the molded hoses back onto the hose nozzles.

→ Example
Assemble device
and housing parts

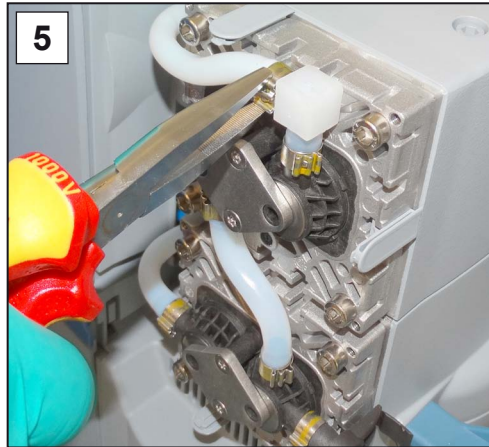

5. Secure the hose clips on the hose nozzles, e. g., with flat nose pliers.



6. Put the head cover cowling on properly.



7. Screw in the screw connections of the head cover cowling; Torx screwdriver TX20.

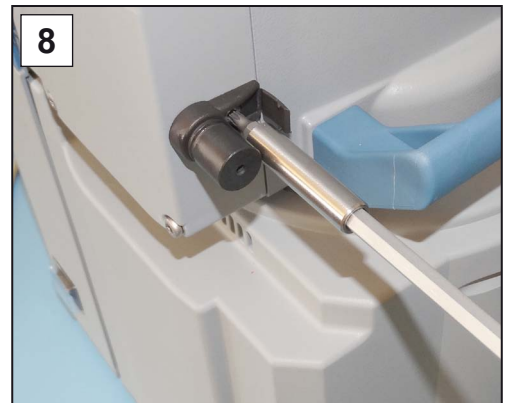

8. Tighten the screw connection and close the cover; Torx screwdriver TX20.

Changing the diaphragm and valve of the next pump head

⇒ Turn the pumping unit to the other side.

⇒ Repeat the steps from the previous descriptions for changing the diaphragm and valve.

7.3.3 Replace pressure relief valve on EK

Pressure relief valve at vapor condenser

20638821



⇒ Pull out the used pressure relief valve and install the new one. Ensure that the PTFE foil under the pressure relief valve lies smoothly on the glass surface.

If maintenance work has been completed in full:

- ⇒ Assemble the EK (if disassembled).
- ⇒ Connect the hoses for operation.
- ⇒ Connect the pumping unit to the power supply.
 - Pumping unit is ready to be returned to use.

If not reconnected:

- Pumping unit is ready for storage.

7.3.4 Change device fuse

At the power connection on the rear side of the pumping unit, there are 2 device fuses, type: 6,3 A/t – 5x20.

Change device fuse



1. Unplug the power plug.



2. Carefully pull out the fuse holder.

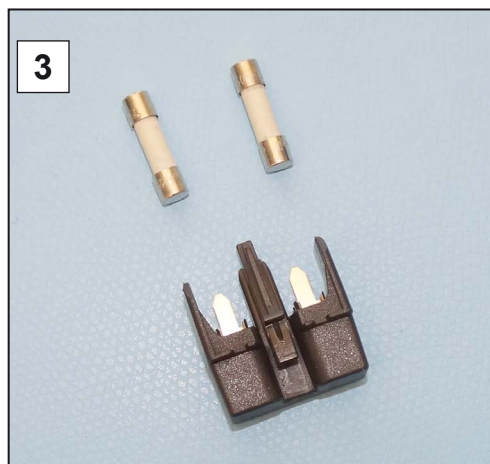

3. Replace the fuses.



4. Push the fuse holder back onto the fuse socket.

8 Appendix

8.1 Technical information

Chemistry pumping unit series	
PC 510 select	PC 610 select
PC 511 select	PC 611 select
PC 520 select	PC 620 select

8.1.1 Technical data

Technical data

Ambient conditions		(US)
Ambient temperature, max.	10–40 °C	50–104°F
Working temperature	10–40 °C	50–104°F
Storage/transport temperature	-10–60 °C	14–140°F
Altitude, max.	2000 m über NHN	6562 ft above sea level
Relative humidity	30–85 %, non condensing	
Protection type	IP 40 / IK 08	

Operating conditions		(US)
Maximum admissible media temperature (gas), non-explosive atmosphere:		
momentarily	80 °C	176°F
Continuous operation	40 °C	104°F
ATEX conformity	II 3/- G IIC T3 X internal atm. only	
Maximum admissible media temperature (gas)  atmosphere:		
momentarily	40 °C	104°F
Continuous operation	40 °C	104°F

Connections	
Vacuum, inlet IN	Hose nozzle DN 8-10
Gas ballast GB	Gas ballast valve, manual
Inert gas adapter – OPTION	Small flange GB NT KF DN 16 Hose nozzle GB NT DN 6/10
Venting valve (venting with inert gas) – OPTION	Silicone rubber hose 3/6
Coolant water EK	2x Hose nozzle DN 6-8
Exhaust gas, outlet EX	Hose nozzle DN 8-10
Cold device plug	+ Power supply CEE, CH, CN, UK, IN, US
Plug-in connector	VACUU·BUS®

Technical data

Electrical data		(US)
Nominal voltage	230 VAC	100-115 / 120 VAC /
Nominal frequency	50-60 Hz	50-60 Hz / 60 Hz
PC 510/511/520		
Max. Nominal current	1,8 A	3.4 A
Nominal capacity	0,18 kW	0.24 hp
PC 610/611/620		
Max. Nominal current	3,0 A	5.7 A
Nominal capacity	0,25 kW	0.34 hp
Nominal speed 50 / 60 Hz	1500 / 1800 Upm	
Device fuse 2x	6,3 A/t 5x20	
Interface	VACUU·BUS®	
Power cable	2 m	
Vacuum data		(US)
PC 510/511/520		
Max. Pumping speed * 50 Hz	2,0 m³/h	1.2 cfm
Max. Pumping speed * 60 Hz	2,3 m³/h	1.4 cfm
Ultimate vacuum, abs.	7 mbar	5 Torr
Ultimate vacuum with GB, abs.	12 mbar	9 Torr
Number of cylinders/stages	2/2	
PC 610/611/620		
Max. Pumping speed * 50 Hz	3,4 m³/h	2.0 cfm
Max. Pumping speed * 60 Hz	3,8 m³/h	2.2 cfm
Ultimate vacuum, abs.	1,5 mbar	1.1 Torr
Ultimate vacuum with GB, abs.	3 mbar	2.2 Torr
Number of cylinders/stages	4/3	
Max. Inlet pressure, abs.	1,1 bar	16 psi
Max. Outlet pressure, abs.	1,1 bar	16 psi
Max. Differential pressure, abs.	1,1 bar	16 psi
Max. Max. pressure at gas connections, abs.	1,2 bar	17.5 psi
Sensor	integriert	integrated
Measuring principle	Ceramic diaphragm (aluminum oxide), capacitive, gas type independent, absolute pressure	
Accuracy of measurement	±1 mbar/hPa/Torr, ±1 digit (after adjustment, constant temperature)	
Upper measurement limit	1080 mbar	810 Torr
Lower measurement limit	0,1 mbar	0.1 Torr
Temperature coefficient	< 0,15 mbar/hPa/K	0.11 Torr/K

* Pumping speed

Weights* and dimensions (l x b x h)		(US)
PC 510 select	418 mm x 243 mm x 457 mm	16.47 in x 9.57 in x 17.99 in
Weight*	17,2 kg	37.9 lb
PC 511 select	435 mm x 243 mm x 457 mm	17.13 in x 9.57 in x 17.99 in
Weight*	17,4 kg	38.4 lb
PC 520 select	435 mm x 243 mm x 457 mm	17.13 in x 9.57 in x 17.99 in
Weight*	17,7 kg	39.0 lb
PC 610 select	419 mm x 243 mm x 457 mm	16.50 in x 9.57 in x 17.99 in
Weight*	20,4 kg	45.0 lb
PC 611 select	435 mm x 243 mm x 457 mm	17.13 in x 9.57 in x 17.99 in
Weight*	20,6 kg	45.4 lb
PC 620 select	435 mm x 243 mm x 457 mm	17.13 in x 9.57 in x 17.99 in
Weight*	20,6 kg	45.4 lb

* without cable

Other information	
Sensor type	VACUU·SELECT Sensor
Controller	VACUU·SELECT
Volume of separator flask	500 ml each
Sound pressure level at 1500 rpm	45 dBA

8.1.2 Wetted materials

Wetted materials

Component	Wetted materials
Pump	
Head cover	ETFE carbon fiber reinforced
Diaphragm clamping disc	ETFE carbon fiber reinforced
Diaphragm	PTFE
Valves	FFKM
O-ring	FKM
Valve terminal	ECTFE carbon fiber reinforced
Gas ballast tube	PTFE carbon fiber reinforced
Angle piece (on the valve terminal)	ETFE/ECTFE
Pumping unit	
Inlet	PBT or PP
Outlet	PET
Distributor head (inlet PC 510/610)	PPS glass fiber reinforced
Valve block (inlet PC 511/520/611/620)	PP
Flow control valve (PC 511/611)	PTFE
Housing (electromagnetic valve)	PVDF / PE / PPS
Electromagnetic valve	Fluoroelastomer
Hoses	PTFE
Hose fitting	ETFE, ECTFE
O-ring on separator	Fluoroelastomer
Pressure relief valve at vapor condenser	Silicone rubber, PTFE film
Vapor condenser	Borosilicate glass
Round bottom flask	Borosilicate glass
VACUU-SELECT Sensor	
Vacuum sensor	Aluminum oxide ceramic, gold-coated
Measurement chamber	PPS
Sealing ring at the sensor	Chemically resistant fluoroelastomer
Venting valve seal	FFKM

8.1.3 Rating plate

Data on rating plate

 ⇒ In the event of an error, note the type and serial number on the rating plate.

⇒ When contacting our Service Department, please provide the type and serial number from the rating plate. This will allow us to provide you with specific support and advice for your device.

Rating plate pumping unit, in general

→ Example Rating plate

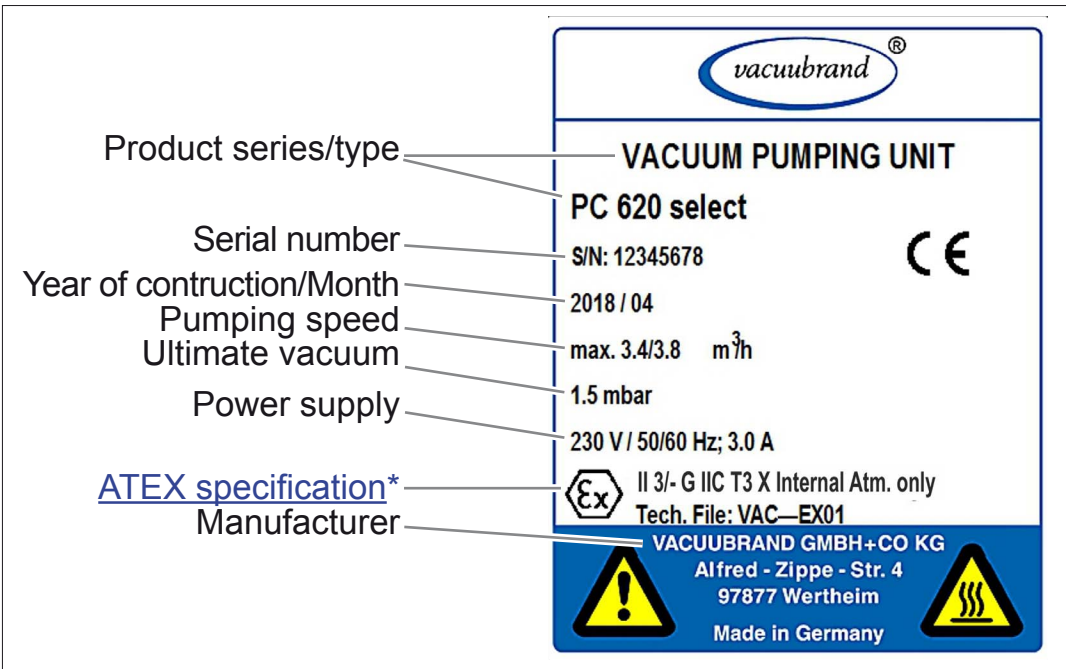

Product series/type	VACUUM PUMPING UNIT
Serial number	PC 620 select
Year of construction/Month	S/N: 12345678
Pumping speed	2018 / 04
Ultimate vacuum	max. 3.4/3.8 m ³ /h
Power supply	1.5 mbar
	230 V / 50/60 Hz; 3.0 A
<u>ATEX specification*</u>	 II 3/- G IIC T3 X Internal Atm. only
Manufacturer	Tech. File: VAC-EX01
	VACUUBRAND GMBH+CO KG
	Alfred - Zippe - Str. 4
	97877 Wertheim
	Made in Germany

* Documentation, group and category, marking G (gas), type protection, explosion group, temperature class (additionally see : [Approval for ATEX equipment](#)).

8.2 Ordering information

Ordering information
for pumping unit
series

Chemistry pumping unit series	Order no.*
PC 510 select	2073315x
PC 511 select	2073325x
PC 520 select	2073335x
PC 610 select	2073715x
PC 611 select	2073725x
PC 620 select	2073735x

* Order no. depends on power cable CEE, CH, UK, US, CN, IN

Ordering information
accessories

Accessories	Order no.
Vacuum hose DN 6 mm (l = 1000 mm)	20686000
Vacuum hose DN 8 mm (l = 1000 mm)	20686001
Coolant valve VKW-B	20674220
Venting valve VBM-B	20674217
Level sensor	20699908
VACUU·SELECT Sensor	20612881
DAkkS calibration with first delivery	20900214
DAkkS recalibration	20900215
Extension cable VACUU·BUS, 0.5 m	20612875
Extension cable VACUU·BUS, 2 m	20612552
Extension cable VACUU·BUS, 10 m	22618493
VACUU·BUS wall duct	20636153
VACUU·BUS® Y adapter	20636656
Digital I/O module VACUU·BUS (e. g. error transmitter, remote module)	20636228
Analog I/O module VACUU·BUS (analog specification and output of pressure and speed)	20636229
Peltronic® emission condenser EKP	20699905
Silencer* (with connection hose)	20636588
Adapter G 1/4 to PTFE tube 10/8 mm, for inlet PC 511/520/611/620	20677060
Small flange KF DN 16, for inlet PC 511/520/611/620	20662593
Sealing ring for small flange KF DN 16 (20662593)	23120565
Hose nozzle DN 6/10, for inlet PC 510/610	20636635
Adapter hose nozzle DN 10 to hose nozzle 1/2"	20636002

* Note: Dust-laden gases, deposits and condensed solvent vapors can impair the gas flow rate of the silencer. This can result in the development of an internal overpressure which can damage the bearings, diaphragms and valves of the pump. Do not use the silencer under such conditions.

Ordering information
accessories

Accessories	Order no.
Hose nozzle DN 6/10, for inlet PC 511/520/611/620	20642470
Supplementary module on small flange KF DN 16 at inlet PC 510/610	20699939
Angle piece (90°) for PTFE tubing DN 10/8, for inlet PC 510/610	20637873
Adapter to gas ballast connection via small flange KF DN 16	20636193
Blind flange (C1) for mounting on the valve block or distributor head	20677136
Manometer element (C5) for mounting on the valve block or distributor head	20677100
PTFE tubing DN 10/8 mm (yard good)	20638644
VMS-B module, 100-230 V 50/60 Hz, plus connection cable	20676030
VACUU·LAN® manual flow control module VCL 01	20677106
VACUU·LAN® shut-off / manual flow control module VCL 02	20677107
VACUU·LAN® automatic control module VCL-B 10	20677208
VACUU·LAN® manual flow control / automatic control module VCL-B 11	20677209

Ordering information
spare parts

Spare parts	Order no.
Hose nozzle 6 rounded	20639948
Joint clip VA KS35/25	20637627
Glass flask/round bottom flask 500 ml	20638497
O-ring 28 x 2.5 on the spherical joint of the flask on the suction side	20635628
PA knurled nut M14x1 (union nut)	20637657
PA locking ring D10 (seal)	20637658
Vapor condenser EK, complete	20699922
Pressure relief valve at vapor condenser	20638821
Gas ballast cap	20639223
Power cable	
CEE	20612058
CH	20676021
CN	20635997
IN	20635365
UK	20612065
US	20612065



⇒ A full list of available spare parts is available under → VACUUBRAND > Support > Repair instructions > [Chemistry pumping units](#).

Sources of supply

International sales offices and specialized trade

Purchase original accessories and original spare parts from a subsidiary of **VACUUBRAND GMBH + CO KG** or your local distributor.



- ⇒ Information about our complete product range is available in the current [product catalog](#).
- ⇒ Your local distributor or **VACUUBRAND GMBH + CO KG** [sales office](#) is available to assist you with orders, questions on vacuum control and optimal accessories.

8.3 Service

Service offer and service range

Take advantage of the comprehensive range of services available from **VACUUBRAND GMBH + CO KG**.



Services in detail

- Product consultation and practical solutions
- Fast delivery of spare parts and accessories
- Professional maintenance
- Immediate repairs processing
- On-site service (on request)
- [Calibration](#) (DAkkS-accredited)
- With Health and Safety Clearance form: return, disposal.

⇒ Visit our website for further information: www.vacuubrand.com

Service handling

Meet the terms of service

1. Contact your local distributor or our Service Department.
2. Request an RMA no. for your order.
3. Clean the product thoroughly or if necessary, decontaminate it professionally.
4. Fill out the [Health and Safety Clearance form](#) in full.
5. Return your product, including:
 - RMA no. and description of the error
 - Repair or service order,
 - Health and Safety Clearance form
 - Attach everything to the outside of the package

Return (reshipment)

⇒  Reduce downtime, speed up processing. Please keep the required data and documents ready when contacting our Service Department.

- ▶ Your order can be quickly and easily processed.
- ▶ Hazards can be excluded.
- ▶ A brief description and/or photos help locate the source of the error.

8.4 Index

Index

A	M
Abbreviations 10, 11	Maintain minimum distance 21
Accessories 79, 80	Maintenance of the pump heads . . . 60
Action step 10	Mandatory sign 9
Additional symbols 9	Manual structure 7
Assemble device and housing parts 70	Measurement chamber 77
ATEX equipment category 23	Minimum distances 35
ATEX equipment labeling 23	
C	O
Clean surface 58	Operate gas ballast valve 48
Connection to VENT port 41	Operating elements
Coolant connection 39	Vacuum controller 46
Copyright © 6	Operating hours until maintenance 56
	Operating panel 11
D	Operation with gas ballast 48
Deadlock protection 22	Operator obligations 15
Diaphragm replacement 64, 65	Ordering information 79, 80
Disassemble housing sections 63	Ordering information pumping unit se- ries 79
Disassemble the device and housing sections 63	Outlet 69
Disassemble the EK 62	Overheating 21
Display conventions 8	Overheating protection 22
Display of action steps 10	Overview
	Chemistry pumping units 28
E	P
EC Declaration of Conformity 85	Peripheral devices and ATEX 23
Electrical connection 43	Personnel obligations 15
Eliminate sources of danger 19	Personnel qualification 16
Empty the glass flask 58	Position VENT port 40
Error – Cause – Remedy 51	Power cable 43
Examples of use 31	Prepare maintenance 62
EX = Exhaust 69	Prevent blocked exhaust gas line . . 19
Exhaust gas connection 38	Prevent condensate reflow 19
Explanation of safety symbols 9	Prevent ignition source 23
Exploded-drawing pump head 61	Process screen (main screen) 46
	Product-specific abbreviations 29
F	Product-specific terms 11, 12
Foreseeable misuse 14, 15	Prohibition sign 9
	Proper disposal 24
G	Protective clothing 17
Goods arrival 33, 34	Pumping unit electrical connection . 43
H	Q
Handling instruction 10	Qualification description 16
Hot surfaces 21	Quality standard 17
I	R
Icons 9	Rating plate 78
Improper use 14	Reset thermal fault 52
Incorrect measurements 19	Residual energies 20
Incorrect measurements avoid 20	Responsibility Assignment Matrix . . 16
IN = Inlet 69	Responsibility matrix and areas of com- petence 16
Inlet 69	Return (reshipment) 82
Instruction modules 7	Return to use after maintenance . . 72
Intended use 13	Risks of venting 20
L	
Limitation of use 35	
Local vacuum network 31	

Index	S
	Safety information 13
	Safety information for vacuum equip- ment 13
	Safety precautions 17
	Sales offices 81
	Service handling 82
	Service range 82
	Spare parts 80
	Start 47
	Stop 47
	Storage, prepared 72
	Switch-off pumping unit 49
	Switch on pumping unit 45
	Symbols 9
	T
	Target groups 16
	Technical data 74, 75
	Technical information 74
	U
	Unpacking 33
	User information 6
	V
	VACUU·BUS® 11
	VACUU·BUS® connector 11
	Vacuum connection 37
	Vacuum controller operation 45
	Vacuum drying 32
	Valve replacement 67
	Valves, pump head 61
	venting 47
	W
	Warning sign 9
	Warning signs and labels 22
	Wetted materials 77

8.5 EC Declaration of Conformity

EU-Konformitätserklärung EC Declaration of Conformity Déclaration CE de conformité



Hersteller / Manufacturer / Fabricant:

VACUUBRAND GMBH + CO KG · Alfred-Zippe-Str. 4 · 97877 Wertheim · Germany

Hiermit erklärt der Hersteller, dass das Gerät konform ist mit den Bestimmungen der Richtlinien:

Hereby the manufacturer declares that the device is in conformity with the directives:

Par la présente, le fabricant déclare, que le dispositif est conforme aux directives:

2006/42/EG (M-RL), 2014/30/EU (EMV-RL), 2014/34/EU (ATEX-RL),
2011/65/EU (RoHS-2)

Chemie-Pumpstand-Serie / Chemistry pumping unit series / Groupe de pompage *chimie*

Typ / Type / Type: PC 510 select, PC 511 select, PC 520 select
PC 610 select, PC 511 select, PC 620 select

Artikelnummer / Order number / Numéro d'article: 20733154, 20733254, 20733354
20737154, 20737254, 20737354

Seriennummer / Serial number / Numéro de série: Siehe Typenschild / See rating plate / Voir plaque signalétique

Angewandte harmonisierte Normen / Harmonized standards applied / Normes harmonisées utilisées: DIN EN ISO 12100:2011, DIN EN 1012-2:2011, IEC 61010-1:2010 (Ed. 3), DIN EN 61010-1:2011, DIN EN 61326-1:2013, DIN EN 1127-1:2011, DIN EN 13463-1:2009, DIN EN 50581:2013

Bevollmächtigter für die Zusammenstellung der technischen Unterlagen / Person authorised to compile the technical file / Personne autorisée à constituer le dossier technique: Dr. J. Dirscherl · VACUUBRAND GMBH + CO KG · Germany

Ort, Datum / place, date / lieu, date: Wertheim, 28.06.2018



(Dr. F. Gitmans)

*Geschäftsführer / Managing Director /
Gérant*

ppa.



(Dr. J. Dirscherl)

*Technischer Leiter / Technical
Director / Directeur technique*

VACUUBRAND GMBH + CO KG

Alfred-Zippe-Str. 4
97877 Wertheim

Tel.: +49 9342 808-0

Fax: +49 9342 808-5555

E-Mail: info@vacuubrand.com

Web: www.vacuubrand.com



Technology for Vacuum Systems

Manufacturer:

VACUUBRAND GMBH + CO KG
Alfred-Zippe-Str. 4
97877 Wertheim
GERMANY

Phone:

- Head office +49 9342 808-0
- Sales +49 9342 808-5550
- Service +49 9342 808-5660

Fax: +49 9342 808-5555

E-Mail: info@vacuubrand.com

Web: www.vacuubrand.com